



2025



**LPC – La Piscine Collective**  
43 rue des Taillandiers  
72800 – Le Lude  
France

Lundi au vendredi  
08h30 – 12h00  
13h30 – 17h00

02 43 45 19 60  
[contact@lapiscinecollective.com](mailto:contact@lapiscinecollective.com)

## NOS PARTENAIRES

 **BAYROL**  
your pool & spa water expert

 **EMCO**

 **SYCLOPE**  
Electronique

 **Golfinho**  
SPORTS

 **Rez**

 **eco creation**

Chers clients,

### Gagnez en rapidité et en efficacité !

Pour vous garantir un service optimal, nous vous invitons à créer votre compte client directement sur notre site internet. Cet espace vous permet de :

- **Faire vos demandes de devis**
- **Suivre l'historique de vos commandes**

Créer votre compte client est simple et rapide. Rendez-vous sur [www.lapiscinecollective.com](http://www.lapiscinecollective.com) et laissez-vous guider.

Vous trouverez aussi sur notre site web nos fiches techniques et nos fiches de données de sécurité. Vous pouvez également nous en faire la demande par mail si besoin.

Pour mieux vous identifier et vous assurer un suivi rigoureux, nous vous remercions de mentionner dans vos mails et lors de vos appels :

- **Votre code client**
- **Le n° de devis, commande ou facture concerné**

Ces informations sont présentes en haut à droite de nos documents de ventes. En les intégrant à nos échanges, vous nous aidez à vous apporter des réponses claires et précises.

### Nous vous remercions pour votre confiance !

À bientôt,  
L'équipe LPC

Rendez-vous sur notre site pour découvrir tous nos produits en scannant ce QR code :



[www.lapiscinecollective.fr](http://www.lapiscinecollective.fr)

**LUDIQUE****Pataugeoire**

Jeux en mousse  
Jeux d'eau



p. 6

**Découverte**

Brassards  
Ballons gonflables  
Tapis et radeaux

p. 9

**Jeux et animations**

Jeux lestés  
Jeux flottants  
Parcours flottants  
Cages et échelles aquatiques  
Toboggans  
Nautilus

p. 16

**ACTIVITÉS SPORTIVES****Natation**

Planches, pull-buoys et paddles  
Ceintures de flottaison  
Bonnets de bain  
Palmes courtes et longues  
Tubas



p. 28

**Waterpolo**

Buts et accessoires de waterpolo  
Ballons de waterpolo

p. 32

**Aquagym**

p. 34

**ÉQUIPEMENTS****Piscine**

Grilles de goulottes et accessoires  
Plots de départs et accessoires  
Échelles, mains-courantes et accessoires  
Plongeoirs  
Lignes de nage, enrouleurs et accessoires  
Signalisation virage dos et faux départ  
Panneaux et plaques signalétiques  
Horloges et compte-secondes



p. 40

**Sauna - Hamman**

Essences de hammam  
Essences de sauna  
Poêles électriques  
Accessoires de sauna-hammam

p. 58

**MOBILIER****Accueil et terrasse**

p. 62

**Bains de soleil**

p. 64

**Rangement fixe**

p. 65

**Rangement mobile**

p. 66

**Stratifié compact**

p. 71

**Utilitaires**

p. 73

**VESTIAIRES****Casiers et accessoires**

p. 76

**Bancs et patères**

p. 78

**Serrures et accessoires**

p. 81

Serrures mécaniques

Bracelets et poches de protection

**Séches-cheveux**

p. 83

**Tables à langer****et chaises hautes**

p. 83

**SÉCURITÉ ET SURVEILLANCE****Matériels de surveillance**

p. 86

Chaises de surveillance

Miroirs de surveillance

Équipements de communication

**Matériels de sauvetage**

p. 91

Perches et bouées de sauvetage

Gilets de sauvetage

Mannequins

**Matériels de premiers secours**

p. 92

Appareils de diagnostic

Immobilisation et transfert

Mobilier d'infirmier

**Matériels d'urgence**

p. 94

Aspiration

Oxygénation

Sacs de secours

**Accessibilité PMR**

p. 96

Fauteuils de mise à l'eau

Fauteuils roulants spécial piscine

Fauteuils roulants spécial plage

Tabourets et sièges de douche

Barres d'appui

**ENTRETIEN ET RÉGULATION****Produits chimiques**

p. 102

Produits de nettoyage

Produits de traitement de l'eau

**Matériels d'entretien**

p. 104

Manches télescopiques et accessoires

Centrale de nettoyage

Protection de la personne

**Appareils de mesure**

p. 106

Thermomètres, hygromètres  
et pH-mètres

Photomètres, réactifs et accessoires

Carnets sanitaires

**Appareils de dosage**

p. 109

Ensembles de régulation

Pompes doseuses et accessoires

Doseurs à galets

**Matériels de filtration**

p. 110

**Matériels de rétention**

p. 111

Plateaux et plateformes de rétention

Pompes de transvasement



Antibactérien



Antifongique



Anti-UV



Étanchéité

FABRIQUÉ  
EN FRANCE

Fabriqué dans l'UE



# Ludique

Pataugeoire  
Découverte  
Jeux et animations





## JEUX EN MOUSSE

Coloris assortis  
Lot de 4



**D179 - Canetons**  
28 x 23 x 3 cm  
15,00 € HT



**D177 - Ours**  
28 x 23 x 3 cm  
18,00 € HT



**D1000 - Dauphins**  
30 cm  
10,00 € HT



**D178 - Poissons**  
28 x 23 x 3 cm  
15,00 € HT



**M090-3 - Homard**  
95 x 76 x 6 cm  
50,00 € HT



**M090-2 - Éléphant**  
95 x 64 x 6 cm  
50,00 € HT



**M090-1 - Baleine**  
90 x 50 x 6 cm  
40,00 € HT

Coloris selon disponibilité  
L'unité

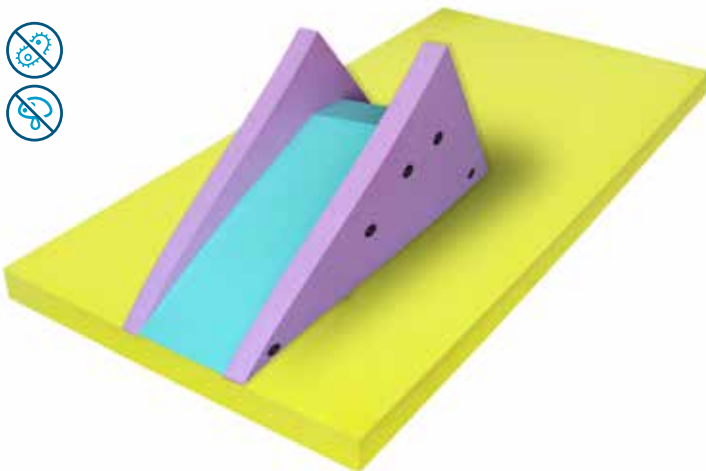

**J021 - Toboggan sur tapis**  
200 x 100 x 90 cm  
648,00 € HT

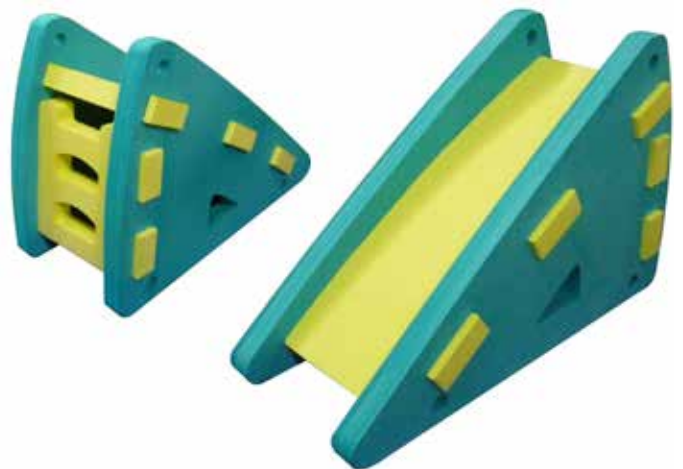

**J022 - Toboggan**  
160 x 60 x 100 cm  
400,00 € HT

Coloris selon disponibilité  
L'unité

## JEUX EN MOUSSE

Coloris assortis et selon disponibilité



### J019 - Puzzle Alphabet

100 x 50 x 3 cm  
26 pièces  
24,00 € HT



### J019-1 - Puzzle Géométrie

68 x 38 x 3 cm  
15 pièces  
12,00 € HT



### J019-2 - Puzzle Alphabet

33 x 33 x 3 cm la pièce  
26 pièces  
130,00 € HT



### J019-3 - Puzzle Chiffre

33 x 33 x 3 cm la pièce  
10 pièces  
50,00 € HT



### J102 - Puzzle poisson

100 x 33 x 3 cm  
15,00 € HT



### J019-4 - Puzzle Animaux

33 x 33 x 3 cm la pièce  
10 pièces  
59,00 € HT



### M13019 - Dés en mousse

16 x 16 cm  
Lot de 2  
18,00 € HT



## JEUX D'EAU

Coloris selon disponibilité



**J077B - Remorqueur**

33 cm  
L'unité  
5,00 € HT



**M115 - Bateaux gigognes**

12 cm  
Lot de 3  
2,25 € HT



**J077 - Bateaux**

15 cm  
Lot de 3  
4,20 € HT



**J089S1 - Seau**

17 cm  
2,00 € HT



FABRIQUÉ  
EN FRANCE



**M113B - Seau garni**

16 cm Ø 15  
5,30 € HT



FABRIQUÉ  
EN FRANCE



**Seau garni Château**

**M114-1 M114-2**  
Ø 15 Ø 20  
6,00 € HT 9,00 € HT



L'unité



**M126A - Moulin à eau**

34 cm x Ø 12 cm  
4,30 € HT



**J089 - Arrosoir**

17 cm  
L'unité  
3,10 € HT



**J091 - Canards**

1 gros, 3 petits 4 canards  
3,80 € HT



**M122 - Moules**

11 cm  
Lot de 8  
3,30 € HT



**M119A - Camion**

22 cm  
L'unité  
4,00 € HT



**J071N1-1 - Kit patageoire**

40 pièces  
38,00 € HT

## JEUX D'EAU

En plastique souple sans phtalates  
À partir de 10 mois

NOUVEAU



**J085B - Aspergeurs Poissons**

Lot de 4  
9,00 € HT

NOUVEAU



**J085C - Aspergeurs Océan**

Lot de 4  
9,00 € HT



**J086A - Aspergeurs Nature**

Lot de 4  
9,00 € HT



**J085A - Aspergeurs Mer**

Lot de 12  
18,50 € HT

## BALLONS GONFLABLES

Coloris selon disponibilité



**M074 - Balle**

Ø 12,5 cm  
L'unité  
2,50 € HT



**M073 - Balle**

Ø 23 cm  
L'unité  
3,50 € HT



**M073D15 - Balle**

Ø 15 cm  
L'unité  
2,50 € HT



**I048 - Pompe manuelle**

3 embouts, 1 buse et 1 tuyau inclus  
6,80 € HT



**M069F29 - Ballon de plage**

Ø 29 cm  
L'unité  
3,50 € HT



**M073BZH - Le ballon Breton**

Ø 23 cm  
L'unité  
2,50 € HT



**L033A - Ballons visage**

Ø 20 cm  
Lot de 6  
30,00 € HT





## BRASSARDS

Paire de brassards LPC  
Ergonomiques et flexibles  
Mousse CO20 - Élastique sandow

NOUVEAU



**LPCBR-1**  
Taille S ●  
Trou Ø 60 mm  
10,00 € HT



**LPCBR-2**  
Taille M ●  
Trou Ø 75 mm  
10,00 € HT



**LPCBR-3**  
Taille L ●  
Trou Ø 87 mm  
11,00 € HT



**LPCBR-4**  
Taille XL ●  
Trou Ø 100 mm  
12,00 € HT



**LPCBR-5**  
Taille XXL ●  
Trou Ø 122 mm  
13,00 € HT

Paire de brassards en mousse  
Élastique sur demande



**810090**  
Taille S ●  
182 x 125 x 85 mm  
Trou Ø 45 mm  
24,00 € HT



**810100**  
Taille M ●  
182 x 125 x 85 mm  
Trou Ø 50 mm  
24,00 € HT



**810110**  
Taille L ●  
197 x 125 x 85 mm  
Trou Ø 60 mm  
24,00 € HT



**810111**  
Taille XL ●  
240 x 125 x 85 mm  
Trou Ø 85 mm  
24,00 € HT



**J044 - Brassard Delphin**  
1 à 12 ans - jusqu'à 60 kg  
Lot de 6 disques  
32,00 € HT

Paire de brassards gonflables



**J002B - Classiques**  
12 - 24 mois < 15 kg  
6,80 € HT

**J004B - Classiques**  
6 - 12 ans 30 à 60 kg  
6,80 € HT



**J003B - Classiques**  
2 à 6 ans 15 à 30 kg  
6,80 € HT

**J005B - Classiques**  
> 12 ans > 60 kg  
6,80 € HT

**J002 - Éco**    **J001 - Éco**  
3 - 6 ans        6 - 12 ans  
23 x 15 cm     30 x 15 cm  
3,90 € HT       4,60 € HT

## TAPIS ET RADEAUX

Coloris selon disponibilité  
Mousse CO2O

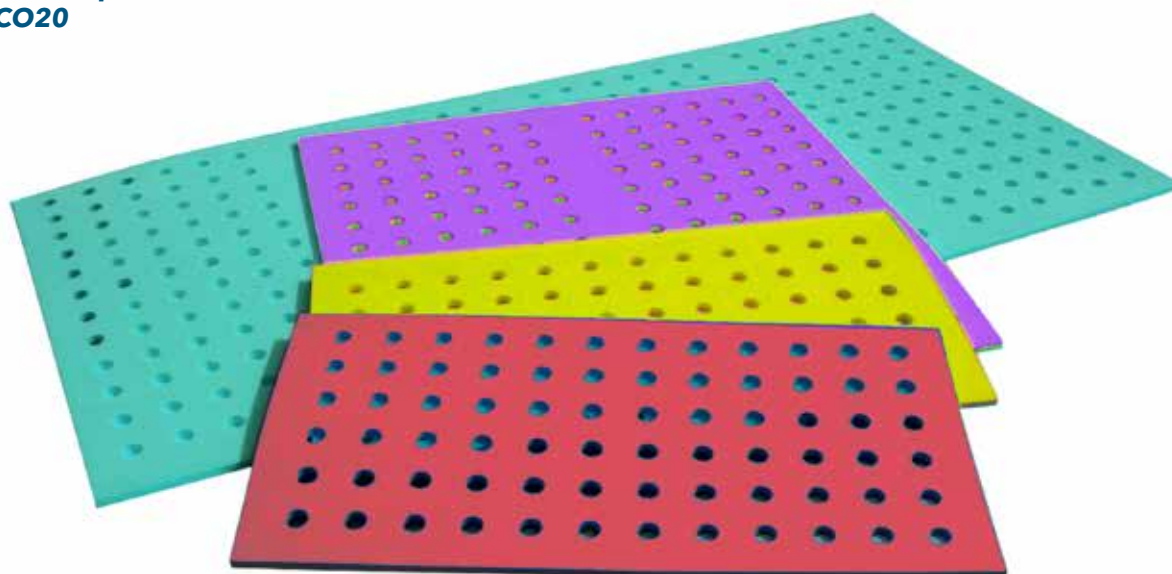

### J023 - Tapis à trous 1,5 cm

100 x 50 cm	150 x 100 cm
28,00 € HT	75,00 € HT
100 x 100 cm	200 x 100 cm
48,00 € HT	80,40 € HT

### J023 - Tapis à trous 3 cm

100 x 50 cm	150 x 100 cm
50,00 € HT	150,00 € HT
100 x 100 cm	200 x 100 cm
79,00 € HT	140,00 € HT

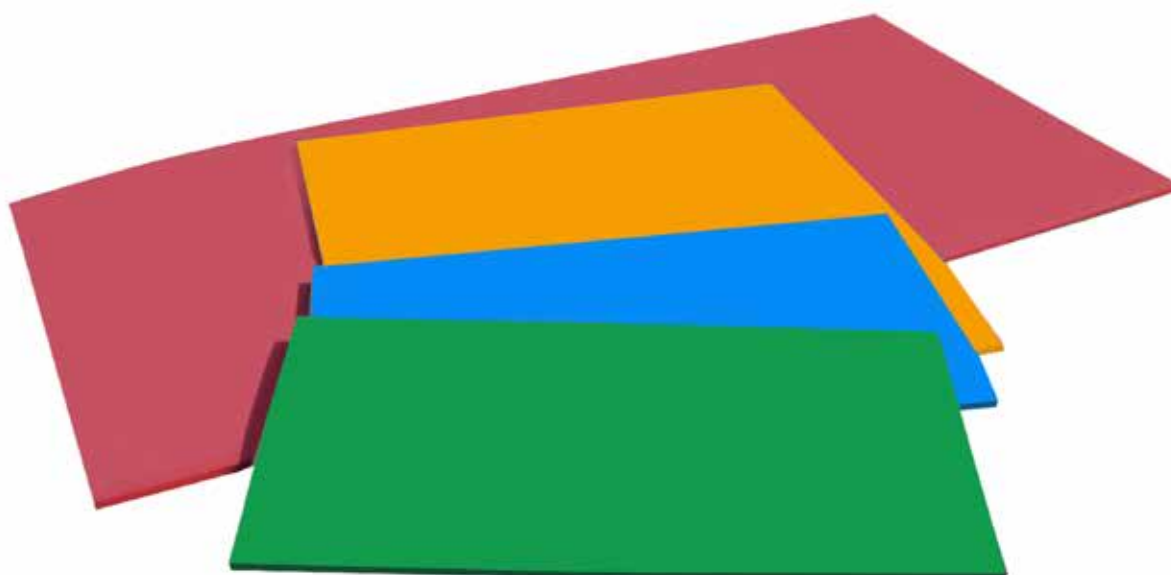

### M011 - Tapis sans trous 1,5 cm

100 x 50 cm	150 x 100 cm
22,00 € HT	50,00 € HT
100 x 100 cm	200 x 100 cm
38,00 € HT	65,00 € HT

### M011 - Tapis sans trous 3 cm

100 x 50 cm	150 x 100 cm
62,00 € HT	85,00 € HT
100 x 100 cm	200 x 100 cm
60,00 € HT	123,00 € HT



## TAPIS ET RADEAUX

Coloris selon disponibilité  
Mousse CO2O



FABRIQUÉ  
EN FRANCE

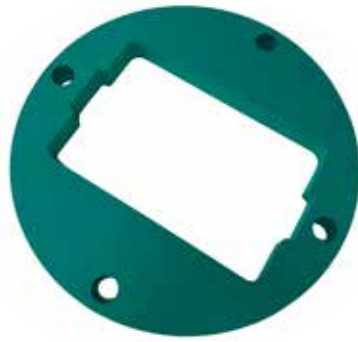

**J020 - Radeau rond**

Ø 100 x 9 cm

150,00 € HT

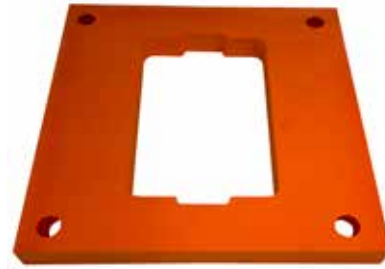

**J020C1 - Radeau simple**

100 x 100 x 9 cm

145,00 € HT



FABRIQUÉ  
EN FRANCE



**J020C - Radeau double**

200 x 100 x 9 cm

320,00 € HT



**J020P - Pаниère**

66 x 43 x 29 cm

62,00 € HT



**D109T - Radeau triple**

200 x 100 x 6 cm

Paniers incluses

215,00 € HT

**J020PG - Pаниère**

64 x 46 x 23 cm

18,00 € HT

## TAPIS ET RADEAUX

Coloris selon disponibilité  
Mousse CO20  
Épaisseur 9 cm - Trous Ø 65 mm

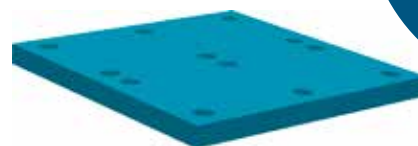
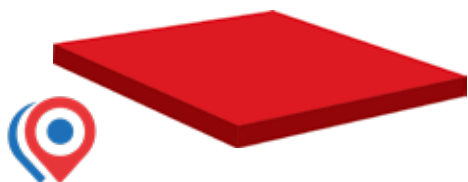

**M090M - Mini**  
100 x 100 cm  
132,00 € HT

**M090M6 - Mini 6 trous**  
100 x 100 cm  
160,00 € HT

**M090M12 - Mini 12 trous**  
100 x 100 cm  
190,00 € HT

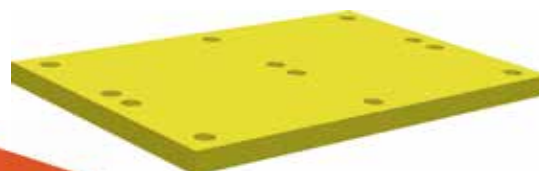

**MED001 - Medium**  
150 x 100 cm  
212,00 € HT

**MED002 - Medium 6 trous**  
150 x 100 cm  
244,00 € HT

**MED003 - Medium 12 trous**  
150 x 100 cm  
290,00 € HT

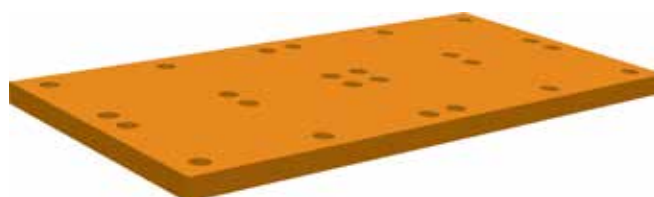
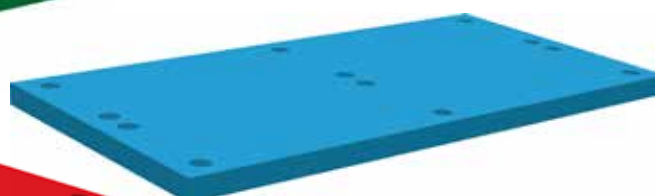

**M090 - Maxi**  
200 x 100 cm  
316,00 € HT

**M017B6 - Maxi 6 trous**  
200 x 100 cm  
299,00 € HT

**M017B12 - Maxi 12 trous**  
200 x 100 cm  
330,00 € HT

**M017B24 - Maxi 24 trous**  
200 x 100 cm  
400,00 € HT



## TAPIS ET RADEAUX



FABRIQUÉ EN FRANCE



**M017AA**  
100 x 50 cm  
85,00 € HT



**M017AC**  
150 x 50 cm  
100,00 € HT

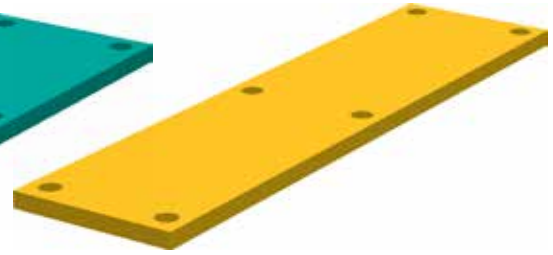

**M017AB**  
200 x 50 cm  
145,00 € HT



FABRIQUÉ EN FRANCE



**PL003 - 1 trou**  
150 x 100 cm  
Ø 60 cm + 6 trous Ø 65 mm  
290,00 € HT



**PL002 - 2 trous**  
200 x 100 cm  
Ø 60 cm + 6 trous Ø 65 mm  
340,00 € HT



**PL001-9 - Plateforme ovale**  
170 x 100 cm  
1 trou de Ø 60 cm + 2 trous Ø 65 mm  
320,00 € HT



FABRIQUÉ EN FRANCE



**M090AC - Mini**  
100 x 100 x 6 cm  
140,00 € HT



**M090A - Maxi**  
200 x 100 x 6 cm  
226,00 € HT



**M026A - Maxi disque**  
Ø 95 x 6 cm  
100,00 € HT

### Barre en inox 316L



**M090C - Barre murale coudée**  
Conçue pour 3 tapis de 9 cm  
130,00 € HT

**M090B - Barre murale droite**  
Conçue pour 6 tapis de 9 cm  
95,00 € HT



FABRIQUÉ EN FRANCE



**M135 - Sangle de jonction pour tapis**  
100 x 2,5 cm  
2,75 € HT



**M076 - Anneau strié**  
 Ø 18 cm  
 L'unité  
 2,50 € HT



**M149 - Anneaux creux**  
 Ø 20 cm  
 Lot de 5  
 11,50 € HT



**M083 - Cerceau**  
 Ø 72 cm  
 L'unité  
 10,50 € HT



**M099 - Poissons**  
 19 x 14 cm  
 Lot de 6  
 5,80 € HT



**M085 - 6 disques numérotés**  
 Ø 10 cm  
 Lot de 6  
 7,00 € HT



**M100 - Bâtons**  
 21 x Ø 2 cm  
 Lot de 5  
 6,00 € HT



**M080-2 - Balles**  
 Lot de 4  
 12,00 € HT



**M080-1 - Poulpes**  
 Lot de 6  
 8,00 € HT



**M184 - Crustacés**  
 Lot de 6  
 34,00 € HT



**GF053 - Jeu du Morpion**  
 Stratifié compact  
 52 x 52 cm  
 75,00 € HT



**M083D - Demi-tunnels subaquatiques**  
 100 x 65 cm  
 Lot de 3  
 40,00 € HT

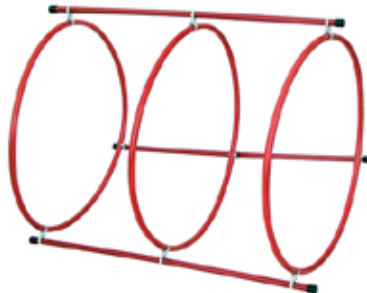

**M185 - Tunnel subaquatique**  
 100 x 75 cm  
 L'ensemble  
 46,00 € HT



## JEUX FLOTTANTS



**M183A - Rondin**  
200 x Ø 27 cm  
430,00 € HT



**M173 - Rondin rigide**  
200 x Ø 25  
158,00 € HT

**Rondin rigide**  
300 x Ø 25 cm  
192,00 € HT



**M175 - Anneau flottant**  
Ø 65 mm 45,00 € HT  
Ø 90 mm 55,00 € HT  
Ø 120 mm 70,00 € HT

**Mousse CO20**  
PE30 et CO30 en option



FABRIQUÉ  
EN FRANCE

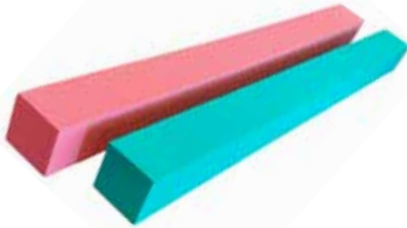

**L045-9 - Frite carrée**  
100 x 8 x 8 cm  
10,00 € HT

**L045-1 - Frite**  
100 x Ø 6,5 cm  
10,50 € HT

**L045-2**  
100 x Ø 7,2 cm  
14,50 € HT

**L045**  
100 x Ø 8 cm  
12,50 € HT



**L045-3**  
120 x Ø 7,2 cm  
16,00 € HT

**L045-4**  
160 x Ø 7,2 cm  
17,00 € HT

**L045-5**  
200 x Ø 7,2 cm  
29,00 € HT



FABRIQUÉ  
EN FRANCE



**L045-7 - Frite bicolore**  
100 x Ø 8 cm  
16,00 € HT



**M004P-1 - Lien plat**  
200 x 90 x 25 cm  
Trous Ø 60 mm  
Pour frite Ø 65 mm  
2,80 € HT

**M004P**  
200 x 90 x 25 cm  
Trous Ø 65 mm  
Pour frite Ø 72 mm  
2,50 € HT

**M004P-2**  
200 x 90 x 25 cm  
Trous Ø 75 mm  
Pour frite Ø 80 mm  
2,90 € HT



**PF2202098 - Maison LPC**  
200 x 100 x 100 cm  
1200,00 € HT





**M15D - Bouée Donut**  
 Ø 94 cm  
 9,00 € HT



**M15P - Bouée Pneu**  
 Ø 114 cm avec deux poignées  
 8,50 € HT



**M15BA - Bouée Baleine**  
 168 x 140 cm  
 25,00 € HT



**M15FC - Bouée Flamant Rose**  
 142 x 137 cm  
 22,00 € HT



**M15DR - Bouée Dragon**  
 201 x 191 cm  
 25,00 € HT



**M15L2 - Bouée Licorne**  
 201 x 140 cm  
 22,00 € HT



**MA606 - Matelas de plage gonflable**  
 188 x 71 cm  
 21,00 € HT

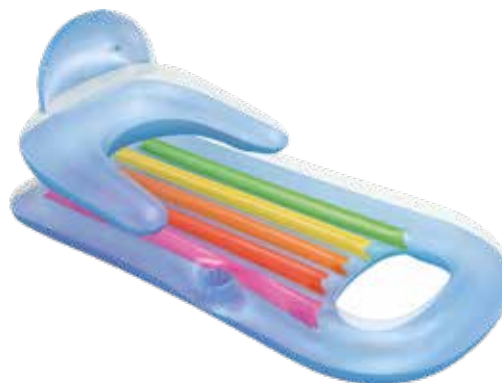

**MA602 - Fauteuil matelas gonflable**  
 160 x 85 cm  
 23,70 € HT





## JEUX FLOTTANTS

Usage intérieur et extérieur

Vinyle rotomoulé

Coloris ● ● ●



### AQU01 - Bouée rotomoulée

Ø 80 x 23 cm

Trou Ø 28 cm

3,8 kg

130,00 € HT

Ø 95 x 30 cm

Trou Ø 40 cm

6 kg

160,00 € HT

Ø 170 x 45 cm

Trou Ø 80 cm

16 kg

Uniquement ● ●

480,00 € HT



### AQU02 - Bouée rotomoulée avec poignées

Ø 80 x 23 cm

Trou Ø 28 cm

3,8 kg

128,00 € HT

Ø 95 x 30 cm

Trou Ø 40 cm

6 kg

155,00 € HT



### AQU03 - Rondin rotomoulé

95 x Ø 27 cm

3,4 kg

165,00 € HT

190 x Ø 27 cm

6,9 kg

225,00 € HT



### GF056 - Panier basket

60 x 40cm

Ballon non inclus

100,00 € HT



### M094 - Cerceau flottant

Ø 72 cm

2,70 € HT



### M153 - Panneau de basket

Panneau stratifié compact

(PVC en option)

Tube et arceau inox

Ø 43 mm

560,00 € HT

NOUVEAU

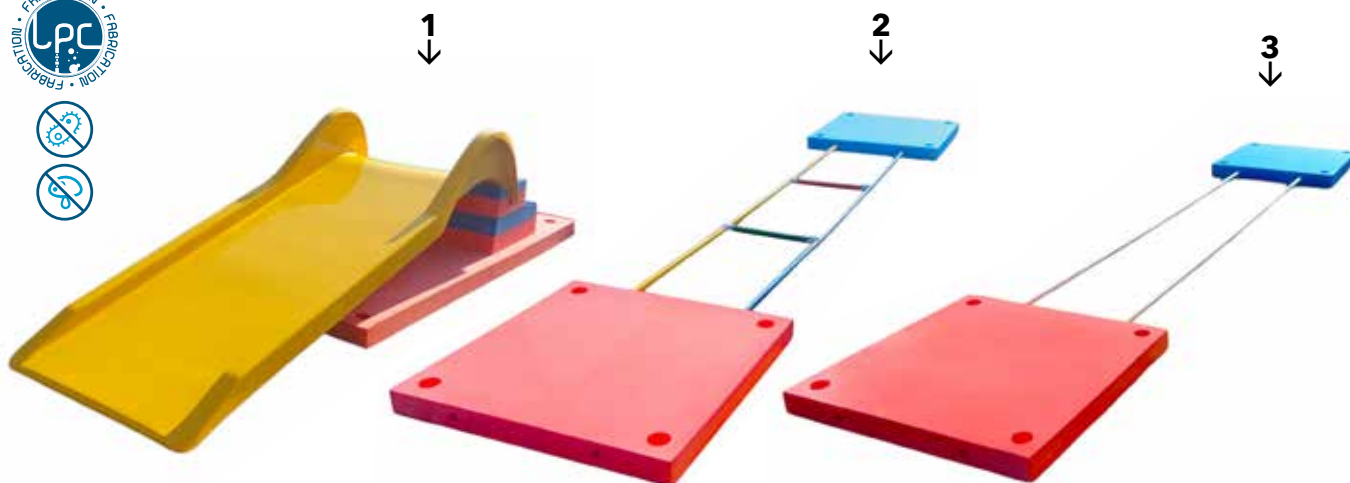

**1 + 2 + 3**  
**LPC-PA3 - Grand parcours aquatique LPC**  
 Toboggan + échelle + pont de singe  
 Jonctions incluses  
 12,5 m  
**2250,00 € HT**

**2 + 3**  
**LPC-PA2 - Parcours aquatique moyen LPC**  
 Échelle + pont de singe  
 10 m  
**1015,00 € HT**

**1**  
**LPC-PA5 - Petit parcours toboggan Monogliss**  
 Accès marche et tapis inclus  
 2,5 m  
**1200,00 € HT**

**2**  
**LPC-PA1 - Petit parcours pont de singe**  
 5 m  
**500,00 € HT**

**3**  
**LPA-PA1-1 - Petit parcours échelle**  
 5 m  
**555,00 € HT**

NOUVEAU



**H041G-1 - Pont de singe spécial apprentissage**  
 2 lignes sans flotteurs  
 Supports en T en option  
 À partir de 5 m  
**10,00 € HT le mètre linéaire**





**LE PARC DES BAMBINS**

6 mois à 2 ans



FABRIQUÉ  
EN FRANCE

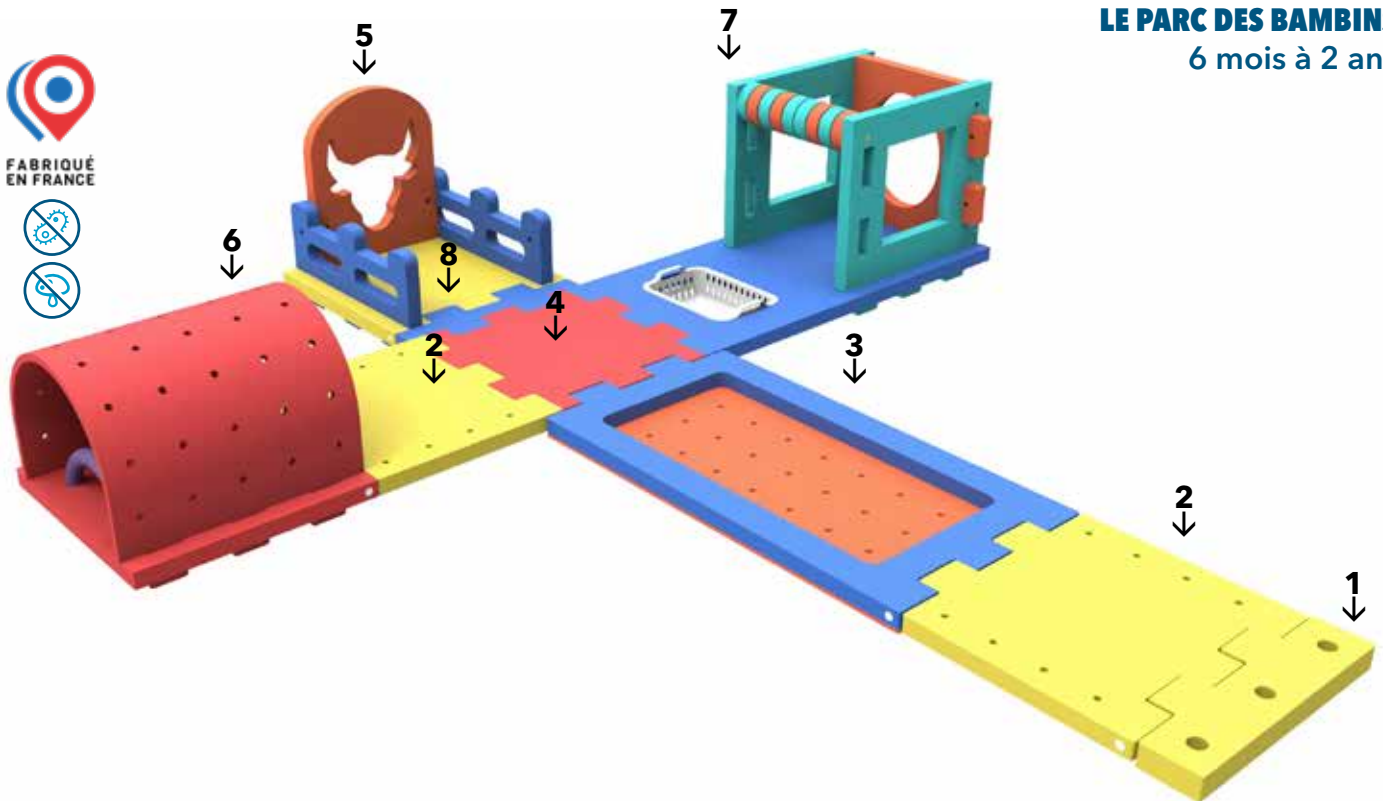

**1**  
**MA001-23B - Raccord mixte mâle**  
100 x 30 x 9 cm  
85,00 € HT

**2**  
**MA001-7B - Petit tapis simple**  
100 x 100 x 7 cm  
217,00 € HT

**3**  
**MA001-18B - Pataugeoire maxi**  
200 x 100 x 9 cm  
532,00 € HT

**4**  
**MA001-13B - Tapis toutes directions**  
100 x 100 x 7 cm  
267,00 € HT

**5**  
**MA001-56 - Bébé Ranch**  
100 x 100 x 100 cm  
550,00 € HT

**6**  
**MA001-55 - Hutte de bébé**  
100 x 100 x 100 cm  
370,00 € HT

**7**  
**MA001-46 - Maison bébé Robinson**  
200 x 100 x 100 cm  
1038,00 € HT

**8**  
**MA001-26B - Raccord mâle-mâle**  
100 x 30 x 9 cm  
85,00 € HT

*Parcours individuels*



FABRIQUÉ  
EN FRANCE

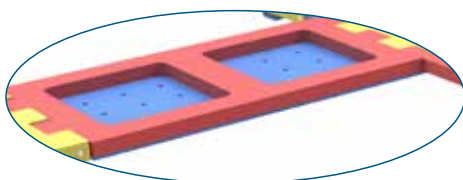

**MA001-17B - Pataugeoire double**  
200 x 100 x 9 cm  
6 mois à 2 ans  
532,00 € HT



**MA001-53 - Saut d'obstacles I**  
200 x 100 x 17cm  
2 ans à 6 ans  
585,00 € HT

**LE PETIT BAROUDEUR**

3 ans à 6 ans



FABRIQUÉ EN FRANCE

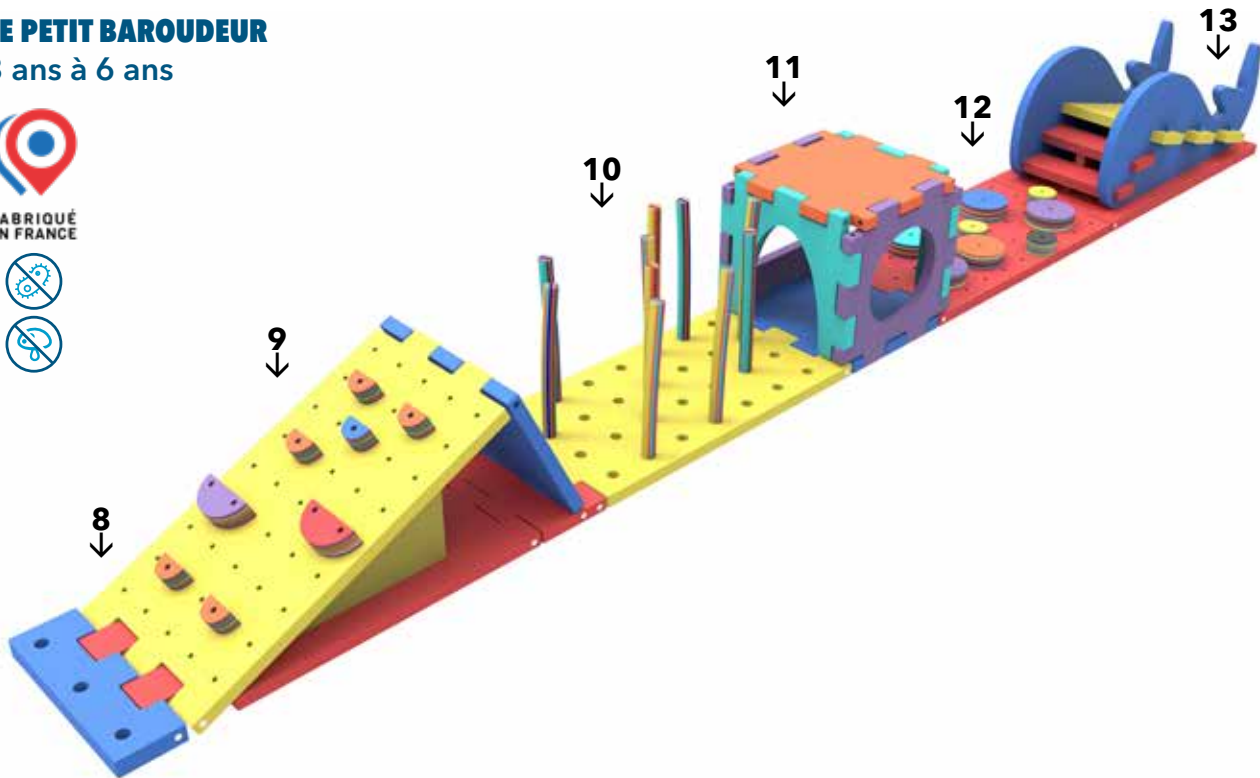

**8**  
**MA001-24B - Raccord mixte femelle**  
 100 x 30 x 9 cm  
 85,00 € HT

**9**  
**MA001-47 - Mur d'escalade flottant**  
 250 x 100 x 80 cm  
 4 à 6 ans  
 1318,00 € HT

**10**  
**MA001-48 - Maxi labyrinthe**  
 200 x 100 x 7 cm  
 6 mois à 6 ans  
 620,00 € HT

**11**  
**MA001-49 - Maison Ludi'O avec toit**  
 100 x 100 x 100 cm  
 1340,00 € HT

**12**  
**MA001-50 - Tapis à pois**  
 200 x 100 x 17 cm  
 6 mois à 6 ans  
 650,00 € HT

**13**  
**MA001-51 - Toboggan Balein'O**  
 200 x 100 x 100 cm  
 6 mois à 6 ans  
 1736,00 € HT

*Parcours individuels*



FABRIQUÉ EN FRANCE

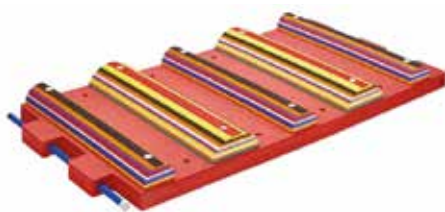

**MA001-52 - Tapis combiné**  
 200 x 100 x 17 cm  
 2 ans à 6 ans  
 770,00 € HT

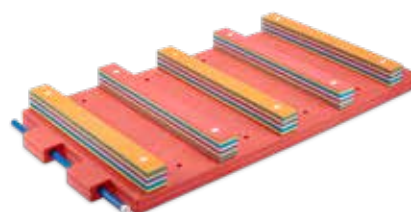

**MA001-6B - Grand tapis simple**  
 200 x 100 x 7 cm  
 416,00 € HT



## PARCOURS FLOTTANTS

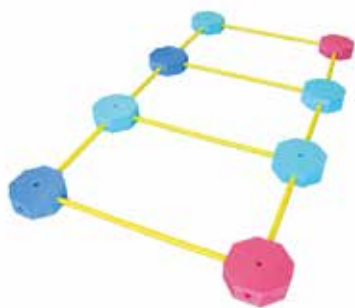

### GF0108 - Parcours 8 flotteurs

+ 4 barres de 1 m  
+ 6 barres de 60 cm  
**88,00 € HT**



### GF01020 - Parcours 20 flotteurs

+ 16 barres de 1 m  
+ 15 barres de 60 cm  
**215,00 € HT**

### L075AHEX - Flotteur octogonal

Ø 26 x 8,5 cm  
**14,50 € HT**



FABRIQUÉ  
EN FRANCE



**Charge admissible 35 kg**  
*Renforcé pour adultes en option*

### M017 - Ponceau flottant

Mousse PE GA40  
Largeur 120 cm  
À partir de 5 m  
**55,00 € HT le mètre**



### M040T - Tapis flottant vertical

PVC  
200 x 160 cm  
1 trou de Ø 75 cm  
2 œillets de fixation  
**164,00 € HT**



FABRIQUÉ  
EN FRANCE



### M040 - Tapis flottant vertical

PVC  
200 x 160 cm  
2 trou de Ø 75 et Ø 60 cm  
2 œillets de fixation  
**175,00 € HT**

# CAGES ET ÉCHELLES AQUATIQUES

Passages colorés non inclus



**M053 - Cage 24**  
150 x 150 cm  
621,00 € HT



**M054 - Cage 27**  
200 x 200 cm  
890,00 € HT

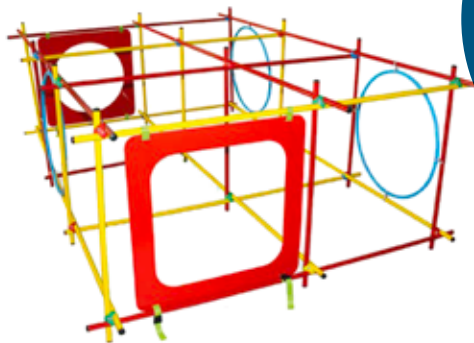

**J267 - Cage 30**  
300 x 200 x 100 cm  
604,00 € HT



**J2642 - Passage rond**  
65,00 € HT



**J2544 - Passage triangle**  
65,00 € HT

**J2643 - Passage carré**  
65,00 € HT



**J2545 - Passage hexagonal**  
65,00 € HT



**J265 - Passage cercle**  
15,00 € HT

## Échelles aquatiques Barres Ø 30

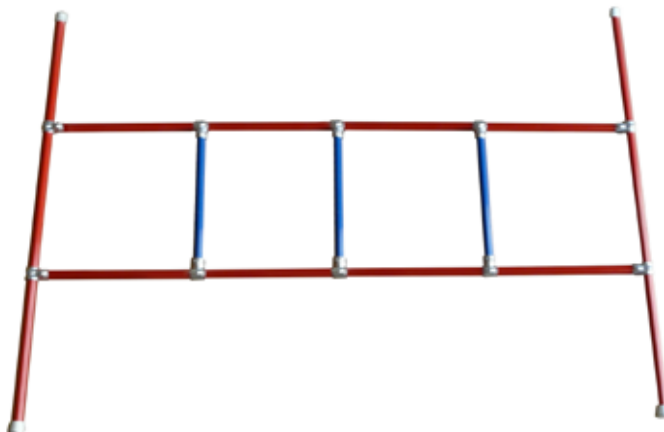

**M053E - 1,50 m**  
165,00 € HT

**M053EP - 2 m**  
196,00 € HT

**M053EP3 - 3 m**  
255,00 € HT



**M056 - Jonction boule**  
Ø 25  
7,00 € HT



**M0572T30 - Jonction en T**  
Ø 30  
10,50 € HT



**M0573T30 - Jonction 3 sorties**  
Ø 30  
14,00 € HT

**M05632**  
Ø 30  
10,00 € HT



**Embout couvrant**  
**M058**  
Ø 30  
2,50 € HT



**M103 - Embout entrant**  
Ø 30  
1,25 € HT

LUDIQUE



## TOBOGGANS

NOUVEAU



### LPC-T1 - Toboggan LPC sur roues

Monté sur 4 roues  
Hauteur 196 cm  
Hauteur assise 125 cm  
Longueur 259 cm  
**3000,00 € HT**

NOUVEAU



### LPC-T2 - Toboggan LPC classique

Longueur 270 cm  
Largeur 125 ou 150 cm  
**À partir de 2000,00 € HT**



### M070M - Toboggan rigide

Glissière 200 cm  
Assise 50 x 40 cm  
**690,00 € HT**

### M070GM - Toboggan rigide

Glissière 205 cm  
Assise 62 x 40 cm  
**730,00 € HT**

## TOBOGGANS

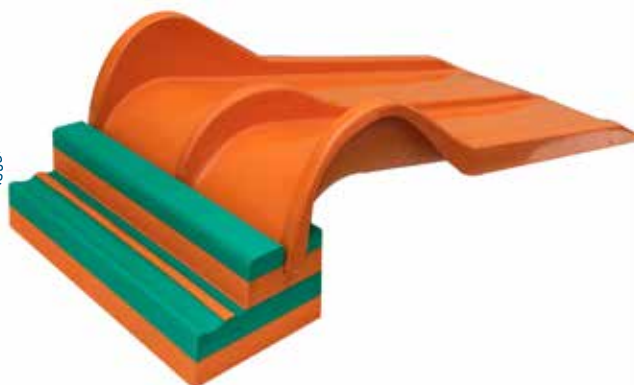

### M158 - Toboggan Bigliss

Marches non incluses  
Jusqu'à 10 ans  
240 x 108 cm  
Au sol 250 cm  
660,00 € HT



### M158-1 - Toboggan Monogliss

Marches et tapis non inclus  
Jusqu'à 10 ans  
240 x 108 cm  
Au sol 250 cm  
660,00 € HT

### M158A-1 - Marches d'accès

Mousse PE  
110 x 48 x 33 cm  
270,00 € HT

## NAUTILUS

Base Ø 120 cm  
Hauteur 80 cm  
Trou supérieur Ø 50 cm



**NAUTI - Nautilus Original**  
600,00 € HT



**Nautilus Bulle**  
Bulle plexiglas  
650,00 € HT



**Nautilus Plaque**  
Plaque plexiglas  
630,00 € HT





# Activités Sportives

Natation  
Waterpolo  
Aquagym





## PLANCHES, PULL-BUOYS ET PADDLES

Mousse PE



**GF022 - Planche petit format**  
29 x 22 x 3 cm  
10,00 € HT



**J029 - Planche standard**  
48 x 27,5 x 3,5 cm  
10,80 € HT



**J031 - Planche à poignées**  
45 x 30,5 x 3 cm  
16,00 € HT



**PL009G - Planche à trous**  
39 x 32 x 3 cm,  
2 trous Ø 4 cm  
20,00 € HT

*Chape avec une partie plus développée*  
Mousse PE



**J047 - Pull-buoys standard**  
23 x 14,5 x 7/8 cm  
7,50 € HT



**J046 - Pull-buoy junior**  
23 x 11 x 5/6 cm  
6,00 € HT

## PLANCHES, PULL-BUOYS ET PADDLES



FABRIQUÉ EN FRANCE



**GFO52 - Paddles**  
Taille L  
5,50 € HT



**GFO51 - Paddles**  
Taille M  
5,00 € HT



**GFO50 - Paddles**  
Taille S  
4,50 € HT

## CEINTURES DE FLOTTAISON



**J036A5 - Ceinture 5 flotteurs**  
Sangle pvc  
Boucle inox  
15,00 € HT



**J036 - Ceinture 4 flotteurs**  
Sangle pvc  
Boucle inox  
14,00 € HT



### J042 - Flotteur de recharge

Se décline en plusieurs matières et tailles

**PE30**  
180 x 70 x 35 mm  
1,50 € HT

**CO20**  
180 x 70 x 35 mm  
1,75 € HT

**CO30**  
180 x 70 x 45 mm  
1,75 € HT

**PE30**  
180 x 70 x 45 mm  
1,75 € HT

**CO20**  
180 x 70 x 45 mm  
2,00 € HT

**PE30**  
180 x 70 x 65 mm  
2,00 € HT

**CO20**  
180 x 70 x 65 mm  
2,25 € HT



**NOUVEAU**



FABRIQUÉ EN FRANCE

Sangle PVC

Boucle inox

Coloris ●●●○



**Sangles**

**J038**

1,20 m

8,00 € HT

**J038P**

1,00 m

6,50 € HT

**J038P8**

0,80 m

6,50 € HT





## PALMES COURTES ET LONGUES

100 % caoutchouc  
1 couleur par taille



### MAD01 - Palmes courtes

26/29 ●	36/37 ●	42/43 ●
13,00 € HT	13,00 € HT	16,00 € HT
30/33 ●	38/39 ●	44/45 ●
13,00 € HT	16,00 € HT	19,00 € HT
34/35 ●	40/41 ●	46/48 ●
13,00 € HT	16,00 € HT	19,00 € HT



### L013 - Palmes courtes Cressi Light

Pour l'aquagym et l'entraînement

31/32 - 33/34 - 35/36 - 37/38 - 39/40 - 41/44 - 43/44 - 45/46



29,00 € HT

### L013BL



29,00 € HT

100 % caoutchouc  
1 couleur par taille



### MAD02 - Palmes longues

26/29 ●	34/35 ●	38/39 ●	42/43 ●	46/48 ●
18,00 € HT	18,00 € HT	18,00 € HT	21,00 € HT	24,00 € HT
30/33 ●	36/37 ●	40/41 ●	44/45 ●	
18,00 € HT	18,00 € HT	18,00 € HT	21,00 € HT	



### K007 - Palmes longues Lagon

Fentes hydrodynamiques

Languette et soufflet permettant un (dé)chaussage facile

Anneau pour le rangement et le transport

Pour le loisir et l'entraînement

30/32 - 33/34 - 35/36 - 37/38 ● ○ ● ●

39/40 - 41/42 - 43/44 - 45/46 ● ○ ● ●

18,00 € HT



## TUBAS



**K077 - Tuba frontal Air senior**  
À partir de 12 ans  
21,00 € HT

**K078 - Tuba frontal Air junior**  
6 à 12 ans  
21,00 € HT



**K077F1 - Tuba frontal Finis senior**  
À partir de 12 ans  
40,00 € HT

**K077FJ - Tuba frontal Finis junior**  
8 à 12 ans  
30,00 € HT

## BUTS ET ACCESSOIRES DE WATERPOLO



**I028COMP - Buts officiels de compétition**  
Homologués FINA et LEN 300 x 90 cm  
Filets non inclus  
La paire  
4940,00 € HT

**I029 - Filets de buts de compétition**  
Maille PP haute résistance Ø 4 mm  
300 x 100 x 80 cm  
La paire  
175,00 € HT



**M061 - Buts d'initiation**  
PVC, nylon et mousse PE  
150 x 70 x h 80 cm  
PVC flottant  
Filets inclus  
La paire  
449,00 € HT

**I029B - Filets spécifiques**  
Nous consulter



**I032 - But gonflable**  
300 x 90 cm  
L'unité  
599,00 € HT

## BALLONS DE WATERPOLO



**I046-13 - Ballon K7 LEN**  
Taille 5  
48,00 € HT



**I046-12 - Ballon K7 LEN**  
Taille 4  
48,00 € HT



**I046-7 - Ballon K7**  
Taille 4 Officiel Junior  
42,00 € HT



**I046-6 - Ballon K7 Multicolore**  
Taille 3 scolaire  
30,00 € HT



**I046-11 - Ballon K7 LEN**  
**Ligue des champions homme**  
Taille 5  
50,00 € HT



**I046-10 - Ballon K7 LEN**  
**Ligue des champions femme**  
Taille 4  
50,00 € HT



**I046-8 - Ballon K7 LEN Multicolore**  
**Femme**  
Taille 4  
50,00 € HT



**I046-5 - Ballon K7**  
Taille 3  
28,00 € HT



## MATÉRIEL D'AQUAGYM

Inox 316L

Fiches techniques sur demande



**DYB003 - Vélo aquatique Variant**

140 x 60 cm  
21 kg  
2300,00 € HT



**DYBD01 - Vélo aquatique Basic**

140 x 60 cm  
19 kg  
1850,00 € HT

NOUVEAU



**WX-ELLY - Vélo elliptique**

Profondeur d'eau 110 à 150 cm  
Aluminium  
118 x 56 x 179 cm  
23 kg  
1400,00 € HT



**CIMA001 - Step LPC**

67 x 35 x 17 cm  
7 kg  
85,00 € HT

**CIMA001V - Ventouse**

Pour step CIMA001  
1,65 € HT



**L041CH - Chariot à step**

140 x 79 x 115 cm  
Capacité 9 steps  
4 roues dont 2 avec frein  
521,50€



## HALTÈRES

La paire  
Mousse PE



**GF027-1 Haltères hexagonaux**  
25 x 20 x 6 cm  
20,00 € HT



**L070 - Haltères plats**  
28 x 15 x 3 cm  
3,80 € HT



**MAD005 - Haltères rigides**  
EVA  
35 x 17 x 12 cm  
30,00 € HT

La paire  
Vinyle



**L062 - Haltères lestés**  
2 x 1 kg  
6,00 € HT

2 x 2 kg  
7,50 € HT

2 x 3 kg  
11,00 € HT

La paire  
Mousse PE et PVC



**L021A - Haltères ronds**  
Mousse PE et PVC  
30 x Ø 15 x 6 cm  
13,50 € HT



**L021F - Haltères carrés**  
30 x 9 cm  
11,00 € HT



**H973M - Haltères croix**  
30 x 16 x 4,5 cm  
11,00 € HT

PVC



**Balle lestée**  
**L034**  
1 kg  
Ø 12 cm  
6,60 € HT

**L035**  
2 kg  
Ø 15 cm  
8,50 € HT



### Bracelets lestés

**L067**

2 x 0,5 kg

16,50 € HT

**L0671**

2 x 1 kg

22,50 € HT

Pour poignets et chevilles  
La paire



**L104 - Bracelets en mousse**

60 x 11,5 x 2 cm

11,00 € HT



**J052 - Chevilles - Donut**

Ø ext. 240 mm

Ø int. 90 mm

8,00 € HT



**J053 - Poignets - Donut**

Ø ext. 120 mm

Ø int. 50 mm

5,50 € HT



**GFD188 - Barre haltères ronds**

107 x Ø 15 cm

Flotteurs Ø 36 cm

L'unité

19,00 € HT

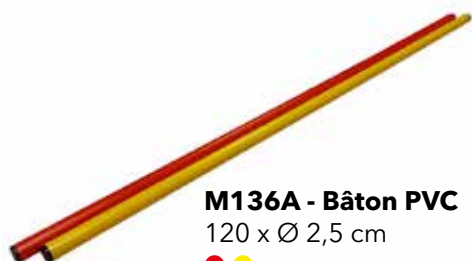

**M136A - Bâton PVC**

120 x Ø 2,5 cm



L'unité

5,00 € HT



**Élastiband**

**L046-1**

Force 10 kg



8,00 € HT



**L046-2**

Force 15 kg



8,00 € HT



**L046-3**

Force 20 kg



9,00 € HT

L'unité



**L075A - Flotteur rond**

25 x 25 x 8,5 cm

14,50 € HT



**L033 - Overball**

Ø 26 cm

7,50 € HT

La paire



**L030AG - Gants d'aquacombat**

Mousse EVA

27 x 17 x 3 cm

10,00 € HT



**L027F - Gants d'aquagym**

Néoprène

Taille S ● Taille M ● Taille L ●

15,00 € HT

Mousse PE



**L113 - Jambières**

Taille L - 30 cm

La paire

22,00 € HT



Taille S - 20 cm

La paire

15,00 € HT



**L038 - Ceinture Aqua**

74 x 22,5 x 4 cm

L'unité

16,00 € HT

## SONORISATION



IPX4

### 17-2505 - Sono Ibiza 300W

Éclairage à LED  
Puissance de sortie totale 300W  
Possibilité de chaîner jusqu'à 3 enceintes  
Entrées AUX, USB, FM, Micro et Guitare  
Bluetooth et NFC  
Écho réglable pour guitare et micro  
Tuner FM avec 4 touches de mémoire

1 power bank USB 5V 1A  
Batterie 12V 4.5A intégrée  
Jusqu'à 7 h d'autonomie  
Roues et trolley télescopique  
Étanchéité IPX4  
51 x 30 x 45 cm  
13,6 kg  
Inclus :

- 1 micro sans fil
- 1 chargeur
- 1 pochette **390,00 € HT**



IP54

### BST001 - Sono 400W

Puissance de sortie totale 400W  
Entrées USB et Micro  
Bluetooth et MP3  
Double récepteur UHF  
Batterie 25.2V 8A  
Jusqu'à 6 h d'autonomie  
Roues et trolley télescopique  
Étanchéité IP54

47,4 x 44,2 x 63,8 cm  
16 kg  
Inclus :

- 2 micros sans fil
- 1 pochette
- 1 télécommande
- 1 chargeur

**990,00 € HT**



IPX4

### IBI001-1 - Sono Ibiza 700W

Puissance de sortie totale 700W  
Possibilité de chaîner jusqu'à 3 enceintes  
Correcteurs de graves et d'aigus  
Contrôle de volume séparé des microphones, écho et haut-parleur  
Entrées AUX, USB, FM, Micro et Guitare  
Lecteur MP3, WMA et WAV via USB et Bluetooth  
Fonction VOX  
Batterie 4500mA intégrée

Jusqu'à 7 h d'autonomie  
Roues et trolley télescopique  
36 x 34,5 x 56 cm  
10,9 kg  
Inclus :

- 1 micro sans fil
- 1 micro-tête
- 1 télécommande
- 1 chargeur
- 1 pochette
- 1 haut-parleur subaquatique 30W

**1190,00 € HT**



### GF054 - Tapis d'animateur

Antidérapant et absorbe les chocs  
100 x 100 x 3 cm  
**45,00 € HT**





# Équipements

Piscine  
Sauna – Hammam

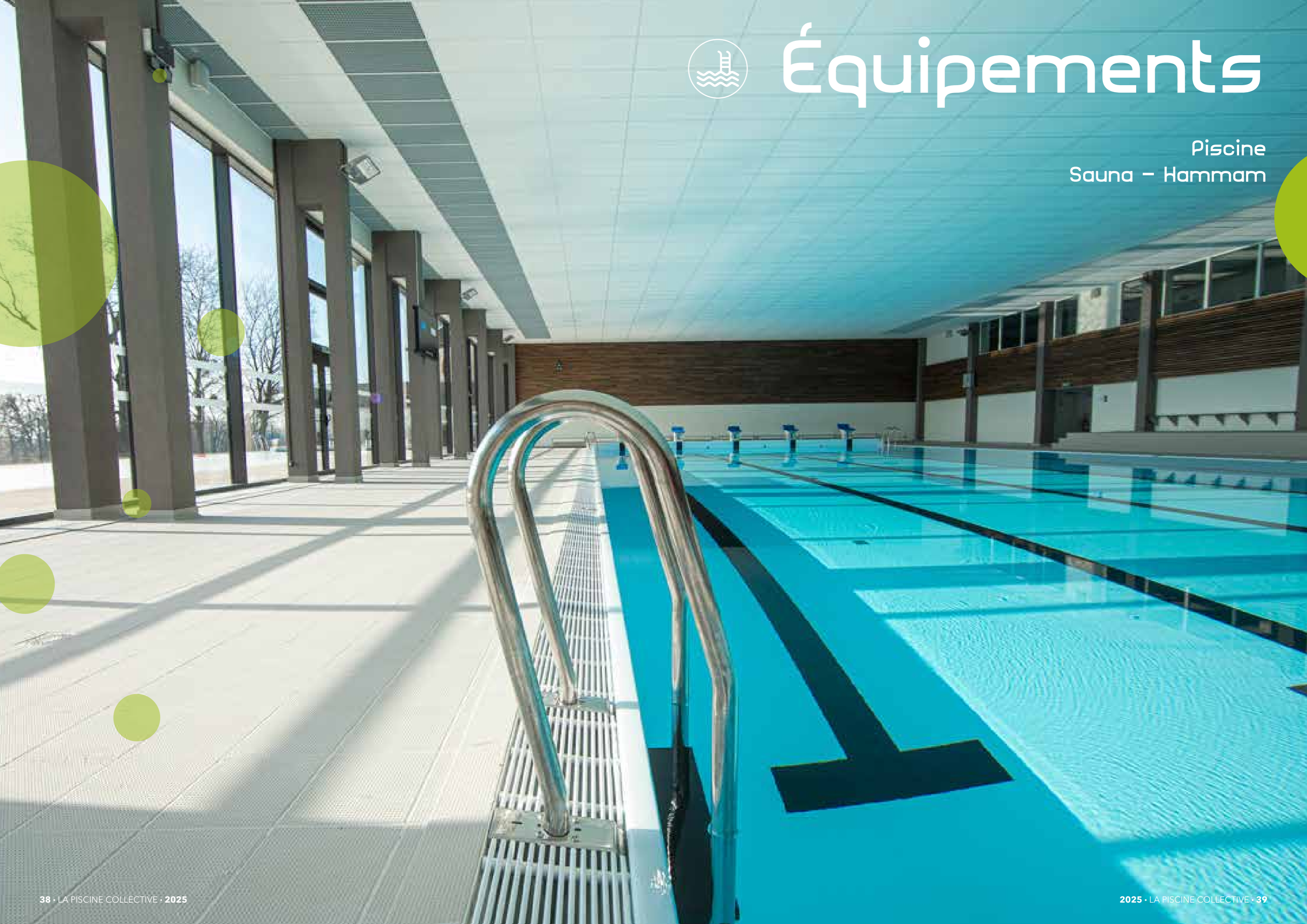



## GRILLES DE GOULOTTES ET ACCESSOIRES

Prise de côtes et pose en option  
PP traité anti-UV  
Le mètre linéaire

Coloris



### Grilles perpendiculaires enroulables

- Liaison câble pur souple avec entretoises
- Largeur 100 à 500 mm
- Profilés pleins 22 x 10 mm
- Écartement des profilés 8 mm
- Antidérapant

**G001**  
22 mm  
132,00 € HT

**G002**  
25 mm  
164,00 € HT

**G003**  
27 mm  
181,00 € HT

**G004**  
35 mm  
205,00 € HT



Prise de côtes et pose en option  
PP traité anti-UV  
Le mètre linéaire

Coloris

### Grille parallèle rigide

- Liaison par tubes porteurs en polyester armés de fibre de verre
- Largeur 100 à 300 mm
- Profilés arrondis largeur 10 mm
- Écartement des profilés 8 mm
- Antidérapant

**G036**  
22 mm  
164,00 € HT

**G038**  
27 mm  
215,00 € HT

**G037**  
25 mm  
210,00 € HT

**G039**  
35 mm  
243,00 € HT

Nous consulter

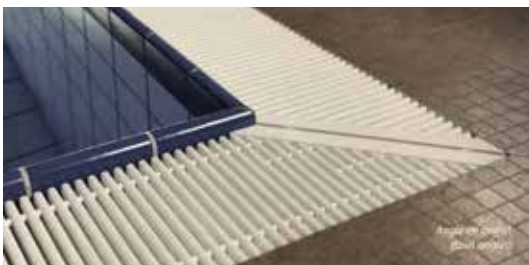

**G042 - Angle en onglet**  
75 à 120°

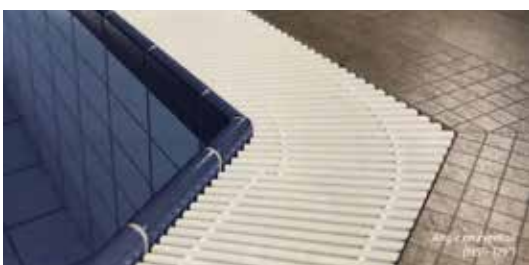

**G042E - Angle en éventail**  
120 à 179°

## GRILLES DE GOULOTTES ET ACCESSOIRES



Prise de côtes et pose en option  
PP traité anti-UV  
L'unité



### Grille perpendiculaire en plaque

<b>G025</b> 200 x 245 x 22 mm 9,00 € HT	<b>G026</b> 200 x 295 x 22 mm 11,00 € HT	<b>G027</b> 200 x 335 x 22 mm 11,00 € HT
---	--	--

Prise de côtes et pose en option  
PP traité anti-UV  
L'unité  
Coloris ● ● ● ● ● ●

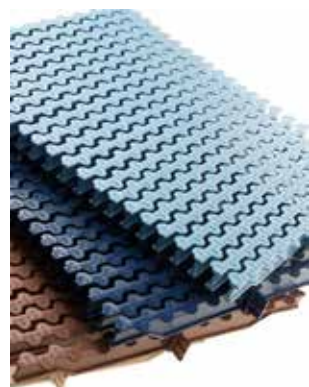
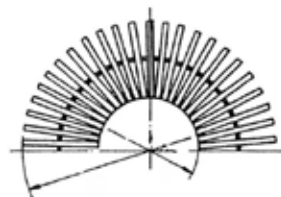
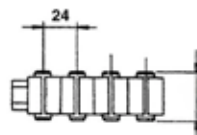

### Grille perpendiculaire spécial arrondi

<b>G017</b> 100 x 195 x 22 mm 1,20 € HT	<b>G020</b> 100 x 335 x 22 mm 1,80 € HT	<b>G018</b> 100 x 245 x 22 mm 1,60 € HT	<b>G019</b> 100 x 295 x 22 mm 1,70 € HT
<b>G023</b> 100 x 295 x 35 mm 2,00 € HT	<b>G021</b> 100 x 195 x 35 mm 1,45 € HT	<b>G024</b> 100 x 335 x 35 mm 2,20 € HT	<b>G022</b> 100 x 245 x 35 mm 2,00 € HT

Perpendiculaires - Caillebotis d'angle à 90°  
L'unité



<b>G017A</b> L195 mm H22 mm 60,00 € HT	<b>G018A</b> L245 mm H22 mm 85,00 € HT	<b>G019A</b> L295 mm H22 mm 100,80 € HT
<b>G020A</b> L335 mm H22 mm 126,00 € HT	<b>G021A</b> L195 mm H35 mm 66,00 € HT	<b>G022A</b> L245 mm H35 mm 82,00 € HT
<b>G023A</b> L295 mm H35 mm 103,00 € HT	<b>G024A</b> L335 mm H35 mm 131,00 € HT	

Prise de côtes et pose en option  
PP traité anti-UV  
5 plaques = 1,024 mètre linéaire



### Grille parallèle en plaque

<b>G072-195</b> 195 x 24 mm 15,00 € HT	<b>G072-245</b> 245 x 24 mm 12,50 € HT	<b>G072-295</b> 295 x 24 mm 16,50 € HT	<b>G072-345</b> 345 x 24 mm 16,00 € HT
--	--	--	--



## GRILLES DE GOULOTTES

Prise de côtes et pose en option

Tarifs au mètre linéaire

Coloris ○ ● ● ● ● ● ●

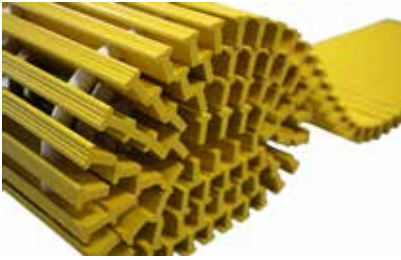

### GR2/22/245 - Grille perpendiculaire enroulable

Largeur entre 100 et 900 mm

Hauteur 22, 25, 30 et 35 mm

À partir de 108,00 € HT



### Grille perpendiculaire courbable

#### GR47/20/295

Largeur 295 mm

Hauteur 20 mm

À partir de 100,00 € HT

#### GR47/25/250

Largeur 180, 200, 205, 250 et 300 mm

Hauteur 25 mm

À partir de 90,00 € HT



### GR20 - Grille parallèle

Largeur 150 à 400 mm

Hauteur 25 mm

À partir de 98,00 € HT



### GLE5013-1 - Tapis antidérapant

60 cm x 10 m

34 kg

425,00 € HT

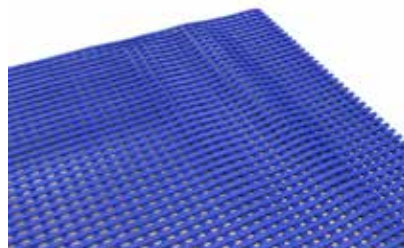

### GLE5013-2 - Tapis antidérapant

120 cm x 10 m

69 kg

850,00 € HT

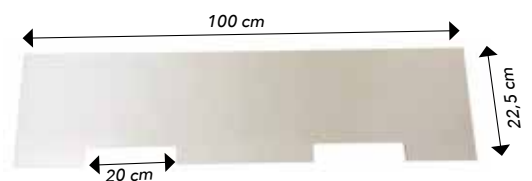

### SOTRAP001 - Plaque antibruit

PVC

100 x 22,5 cm

50,50 € HT

## PLOTS DE DÉPART ET ACCESSOIRES



Normes FINA

Capteur faux départ et logo en option

Numéro inclus

Barre de départ inox 316



### H007 - Plot de départ start droit

Base Inox AISI 316  
500 x 500 x 400 mm

645,00 € HT

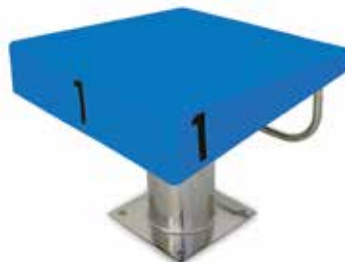

### H004 - Plot de départ base ronde

Base inox 316  
500 x 500 x 400 mm

515,00 € HT



### H007B - Plot de départ start droit

Réglable sur 3 positions  
500 x 500 x 400 mm

670,00 € HT



### H007D - Plot de départ start droit

Barre de départ en U spécial dos crawlé  
Base inox 316

670,00 € HT

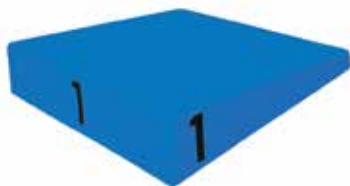

### H011 - Plateforme inclinée

Pour réf. H007 et H004  
Fibre de verre  
500 x 500 mm

214,00 € HT



### H010 - Plateforme renforcée

Pour réf. H007B  
Fibre de verre  
500 x 500 mm

320,00 € HT



### H012 - Numéro

De 0 à 9  
A l'unité  
3,70 € HT



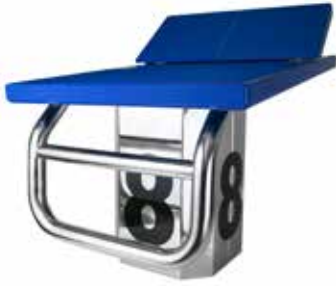

### H001Z - Plot de départ octogonal

Base inox  
240 x 240 mm  
1320,00 € HT

### H001Z1 - Avec track start

1700,00 € HT

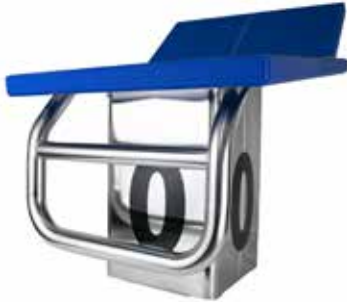

### H002Z - Plot de départ rectangulaire

Base inox  
240 x 240 mm  
1280,00 € HT

### H002Z1 - Avec track start

1650,00 € HT



### H003Z1 - Plot de départ compétition

Avec track start  
Base inox  
310 x 330 mm  
1950,00 € HT



### H004Z1 - Plot de départ compétition

Base PVC  
370 x 400 mm  
3000,00 € HT

### H004Z1-1 - Avec capteur faux départ

4000,00 € HT



### H005Z1 - Plateforme

Avec poignée  
500 x 600 mm  
580,00 € HT

### H005Z2 - Plateforme

Avec poignée et track start  
500 x 700 mm  
1100,00 € HT





## ÉCHELLES, MAINS COURANTES ET ACCESSOIRES

Échelle Ø 48  
Largeur 550 mm  
Inox 316  
Marche de sécurité  
Marche de luxe



**G079**  
3 marches  
1356,00 € HT

**G080**  
4 marches  
1560,00 € HT

**G081**  
5 marches  
1650,00 € HT

### Accessoires pour échelles Ø 48



**G092DE - Marche Polyester**  
500 x 100 mm  
Avec visserie  
● ○ ●  
48,50 € HT



**G093DE - Marche Polyester**  
500 x 150 mm  
Avec visserie  
52,80 € HT



**G092 - Marche Polyester**  
550 x 90 mm  
Sans visserie  
57,00 € HT



**G093 - Marche Polyester**  
550 x 140 mm  
Sans visserie  
90,00 € HT



**G098 - Ancre droit**  
Ø 48  
200,00 € HT



**G099 - Ancre incliné**  
Ø 48  
150,00 € HT



**G101H - Tampon d'échelle oblique**  
Ø 48  
L'unité  
13,20 € HT



**G101 - Tampon d'échelle**  
Ø 48  
L'unité  
4,85 € HT



**Main-courantes sur mesure**  
Inox 316  
Nous consulter



Réalisation, rénovation de plongeoirs  
et pièces détachées : nous consulter



**1**  
**Plongeur sur mesure**  
*Nous consulter*

**2**  
**66-231-330 - Planche de compétition**  
Type Maxiflex B  
14 900,00 € HT

**3**  
**70-231-524 - Ensemble articulation  
arrière et axe de rotation réglable**  
Durafirm  
11 900,00 € HT



**G119ESM - Planche de plongeur**  
480 x 52 cm  
12 700,00 € HT

**G119AS - Planche de plongeur**  
320 x 46,5 cm  
1790,00 € HT



**93950293 - Butée Delta**  
Caoutchouc  
110 x 95 mm  
90,00 € HT le mètre linéaire



## LIGNES DE NAGE, ENROULEURS ET ACCESSOIRES

*Modèle compétition Moscou*  
Montée sur câble inox 316 Ø 4 mm  
Crochet + tendeur à cliquet aux extrémités



**H025-25 - Ligne de nage**  
Ø 100  
25 m  
450,00 € HT

**H026-50 - Ligne de nage**  
Ø 100  
50 m  
840,00 € HT



**H027-25 - Ligne de nage**  
Ø 150  
25 m  
680,00 € HT

**H028-50 - Ligne de nage**  
Ø 150  
50 m  
1350,00 € HT

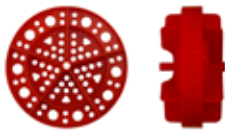

**H029C-NM**  
Disques creux  
Ø 100  
● ○ ● ●  
0,95 € HT

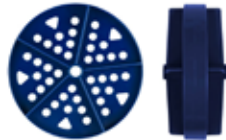

**H029**  
Disques pleins  
Ø 100  
● ○ ● ●  
0,95 € HT

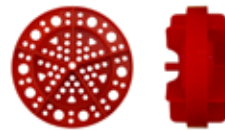

**H029C150**  
Disques creux  
Ø 150  
● ○ ● ●  
2,99 € HT



**H103C**  
Micro donut  
32 x Ø 75 mm  
● ○ ● ● ●  
0,80 € HT



**H041OL - Ligne de nage**  
Câble Ø 4  
25 m  
310,00 € HT

**H041OL-1 - Ligne de nage**  
Câble Ø 4  
50 m  
630,00 € HT

**H041OL-2 - Ligne de nage**  
Corde Ø 6  
25 m  
310,00 € HT

**H041OL-3 - Ligne de nage**  
Corde Ø 6  
50 m  
565,00 € HT



**H103 - Flotteurs Roma**  
47 x Ø 75 mm  
● ○ ● ● ●  
0,80 € HT



**H152 - Sac de rangement**  
Pour ligne de nage de 25 m  
PVC haute résistance  
150 x 100 x 100 cm  
257,50 € HT

**H152A**  
Pour ligne de nage de 50 m  
150 x 120 x 120 cm  
265,00 € HT

## LIGNES DE NAGE, ENROULEURS ET ACCESSOIRES

### Lignes enroulables

Montée sur corde ou câble inox

1 mousqueton et 1 tendeur latex aux extrémités

Intercalaires de 20 cm

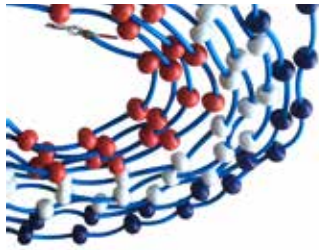

**H041G - Ligne de nage avec intercalaires**  
10,00 € HT le mètre linéaire



**H041GE - Ligne de nage Olupso**  
11,00 € HT le mètre linéaire



**H200OL - Flotteur Olupso**  
70 x Ø 65 mm  
● ○ ● ●  
1,40 € HT



**H050 - Intercalaire**  
PVC souple  
20 cm  
● ●  
0,80 € HT



**H127RON - Rondelle**  
Nylon  
Ø 3 cm x 3 mm  
Trou Ø 82 mm  
0,75 € HT



**H128RON - Rondelle**  
Nylon  
Ø 2,4 cm x 2 mm  
Trou Ø 82 mm  
0,40 € HT

### Coloris des lignes compétitions, entraînements et enroulables Coloris sur demande

25 m

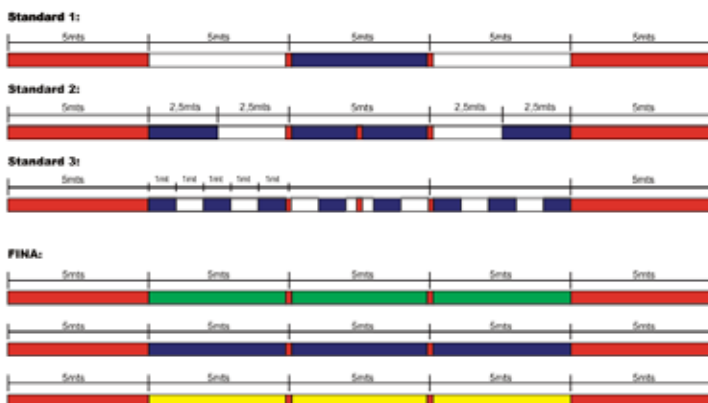

50 m

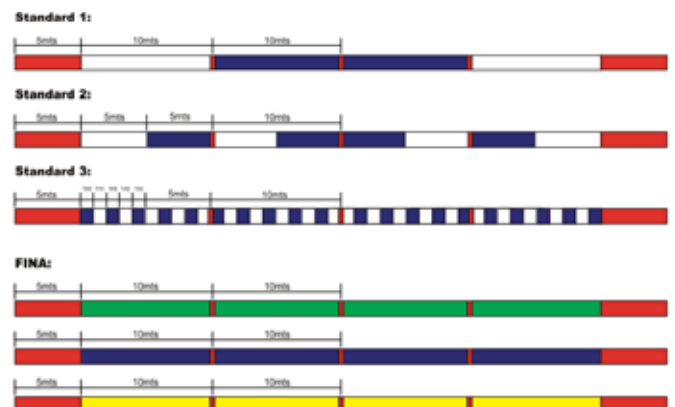



## LIGNES DE NAGE, ENROULEURS ET ACCESSOIRES

Inox 316L



**H069 - Tendeur inox**  
Ø 8 mm    Ø 10 mm  
9,50 € HT    16,00 € HT



**H067A - Tendeur à ridoir**  
65,00 € HT



**H067 - Tendeur à cliquet**  
108,00 € HT



**H068 - Clé mixte**  
19,00 € HT



**H067D - Cache tendeur à cliquet**  
● ●  
10,50 € HT



**H077C - Tendeur latex**  
25,00 € HT



**H075 - Ressort**  
42,00 € HT



**H066 - Corde Polypropylène**  
Bobine de 100 m  
Ø 6    42,00 € HT  
Ø 8    52,00 € HT  
Ø 12    88,00 € HT



**H109A - Mousqueton pompier à œil**  
Ø 8  
5,00 € HT



**H112 - Cosse coeur**  
Ø 4    0,70 € HT  
Ø 5    0,85 € HT  
Ø 6    0,95 € HT



**H074C - Crochet LPC**  
Ø 4    3,60 € HT  
Ø 5    4,20 € HT  
Ø 6    4,80 € HT

Inox



**H131 - Serre-câble étrier**  
Ø 4    3,25 € HT  
Ø 5    5,60 € HT  
Ø 6    8,00 € HT



**H116 - Serre-câble simple**  
Ø 4    2,75 € HT  
Ø 5    5,40 € HT  
Ø 6    6,60 € HT



**H076 - Serre-câble double**  
Ø 4    4,50 € HT  
Ø 5    6,85 € HT  
Ø 6    9,25 € HT

Inox



**Câble gainé H062**  
Ø 3 - 4 mm  
26 m  
53,00 € HT

**H06251**  
Ø 3 - 4 mm  
51 m  
104,00 € HT

**Câble H0621**  
Ø 4 mm  
26 m  
58,00 € HT

**H06215**  
Ø 4 mm  
50 m  
104,00 € HT

**H065G26**  
Ø 4 - 6 mm  
26 m  
60,00 € HT

**H065G1-51**  
Ø 4 - 6 mm  
51 m  
105,00 € HT

Inox

## LIGNES DE NAGE, ENROULEURS ET ACCESSOIRES

Autres pièces détachées nous consulter  
Inox



**H079 - Coupe à sceller standard**  
120,00 € HT



**H080 - Coupe à sceller avec crochet escamotable**  
118,50 € HT



**16600 - Ancre à encastrer**  
108,00 € HT

Inox  
Ø 48 mm sur demande



**H081 - Support de ligne de nage**  
17 cm x Ø 43 mm  
70,00 € HT



**H081-2A - Support ligne de nage**  
Double anneau  
17 cm x 43 mm  
75,00 € HT



**N188 - T pour couloir de jeu**  
Double anneau  
50 cm x 20 cm x Ø 43 mm  
200,00 € HT



**H083 - Ventouse simple**  
Ø 120 mm  
10,80 € HT



**H084 - Ventouse double**  
Ø 120 mm  
18,00 € HT



**HBO084 - Ventouse double**  
Ø 120 mm  
78,00 € HT



**Guide de ligne de nage**  
**H025GU**  
Adaptable à tous types de murets  
PVC  
170 mm  
260,00 € HT



**H025GUL**  
380 mm  
350,00 € HT

**LPC-AP - Attache perche**  
20 cm 115,00 € HT  
25 cm 118,00 € HT  
30 cm 120,00 € HT





## LIGNES DE NAGE, ENROULEURS ET ACCESSOIRES

Inox 304  
Roues en option

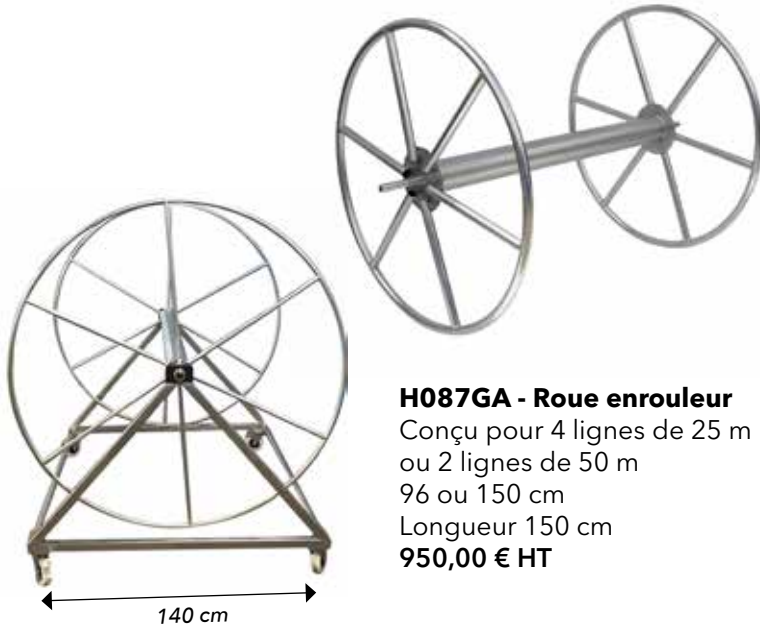

**H087GA - Roue enrouleur**  
Conçu pour 4 lignes de 25 m  
ou 2 lignes de 50 m  
96 ou 150 cm  
Longueur 150 cm  
**950,00 € HT**



**H087GB - Base enrouleur**  
**800,00 € HT**

Aluminium  
Roues en option  
Vendu vide



**H086 - Enrouleur standard mini**  
Conçu pour 2 lignes Ø 100 de 25 m  
80 x 140 x 135 cm  
**1700,00 € HT**

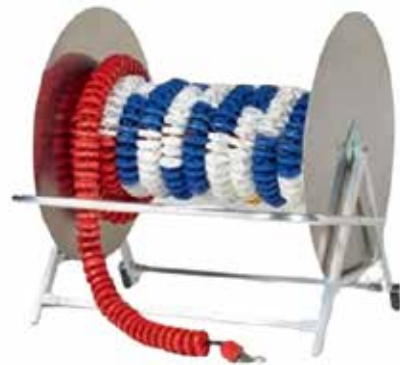

**H087 - Enrouleur standard maxi**  
Conçu pour 4 lignes Ø 100 de 25 m  
140 x 135 x 139 cm  
**1899,00 € HT**

Aluminium  
Roues 4 roues dont 2 avec frein  
Vendu vide

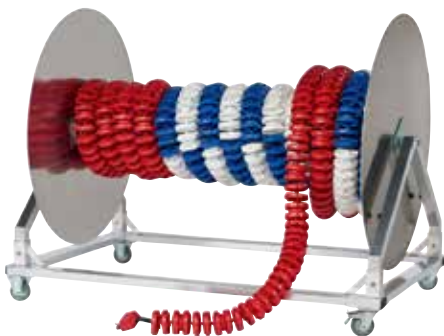

**H088 - Enrouleur luxe mini**  
Conçu pour 3 lignes d'eau Ø 150 mm de 50 m  
ou 6 lignes d'eau Ø 100 mm de 25 m  
178 x 118 x 137 cm  
**2010,00 € HT**

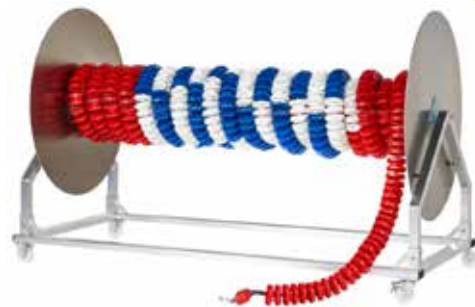

**H089 - Enrouleur luxe maxi**  
6 lignes d'eau Ø 150 mm de 25 m  
ou 12 lignes d'eau Ø 100 de 50 m.  
245 x 118 x 150 cm  
**2750,00 € HT**

## SIGNALISATION VIRAGE DOS ET FAUX DÉPART

Inox 316

Hauteur 180 cm

Équipé d'une poulie et d'un élément de  
fixation et de libération rapide de la corde



ÉQUIPEMENTS

### H052 - Montants faux départ

Ø 43 mm

Lot de 2

350,00 € HT

### H057/2 - Montants virage dos

Ø 43 mm

Lot de 2

300,00 € HT

### H057/2 - Montants virage dos

Ø 48 mm

Lot de 2

300,00 € HT

### H053 - Montants faux départ

Ø 48 mm

Lot de 2

450,00 € HT

### H057 - Montants virage dos

Ø 43 mm

Lot de 4

470,00 € HT

### H057 - Montants virage dos

Ø 48 mm

Lot de 4

470,00 € H



### H056 - Ligne de flotteurs faux départ

Corde polyester

Flotteurs rouges polypropylène

12,00 € HT le mètre linéaire



### H061 - Banderole virages dos

Fanions triangulaires ou rectangulaires

Coloris sur demande

Logo en option

À partir de 3,00 € HT le mètre linéaire



## PANNEAUX ET PLAQUES SIGNALÉTIQUES

Stratifié compact 11 mm  
36 x 30 x 15 cm  
Texte noir recto verso  
Fond coloré selon disponibilité

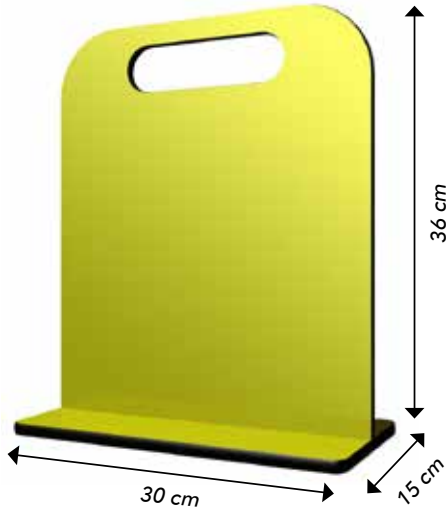

<b>I065ST0</b>	Sans texte	<b>I065ST4</b>	Couloir nageurs confirmés
<b>I065ST1</b>	Couloir réservé	<b>I065ST2</b>	Couloir nage avec palmes
<b>I065ST8</b>	Veillez nager à droite	<b>I065ST30</b>	Couloir nageurs lents
<b>I065ST7</b>	Couloir réservé au club	<b>I065ST38</b>	Nageurs tranquilles
<b>I065ST6C</b>	Couloir réservé au club - associations	<b>I065ST37</b>	Nageurs moyens
<b>I065ST6</b>	Couloir réservé aux associations	<b>I065ST36</b>	Nageurs rapides
<b>I065ST5</b>	Couloir réservé aux leçons	<b>I065ST45</b>	Nage rapide - Matériels autorisés
<b>I065ST28</b>	Couloir réservé PMR	<b>I065ST12</b>	Matériel autorisé
<b>I065ST27</b>	Couloir réservé aux enfants	<b>I065ST19</b>	Réservé à l'Aquabike
<b>I065ST2</b>	Couloir réservé débutants	<b>I065ST18</b>	Réservé activités Aquagym
<b>I065ST24</b>	Couloir réservé nages régulières	<b>I065ST44</b>	Détente et enfants
<b>I065ST23</b>	Couloir réservé nages rapides	<b>I065ST31</b>	Location vélos
<b>I065ST17</b>	Couloir réservé à la brasse	<b>I065ST21</b>	Zone de plongoir
<b>I065ST16</b>	Couloir réservé au crawl	<b>I065ST32</b>	Plongoir fermé
<b>I065ST15</b>	Couloir réservé au public	<b>I065ST29</b>	Pataugeoire fermée
<b>I065ST14</b>	Couloir réservé aux animations	<b>I065ST43</b>	Douche obligatoire
<b>I065ST13</b>	Couloir réservé aux scolaires	<b>I065ST43S</b>	Douche et savonnage obligatoires
<b>I065ST3</b>	Couloir réservé aux nageurs	<b>I065ST39</b>	Interdit de plonger
<b>I065ST4</b>	Couloir baignade libre	<b>I065ST42</b>	Ne pas monter sur le muret
<b>I065ST40</b>	Couloir nageurs loisirs		

72,00 € HT

50 x 40 x 15 cm

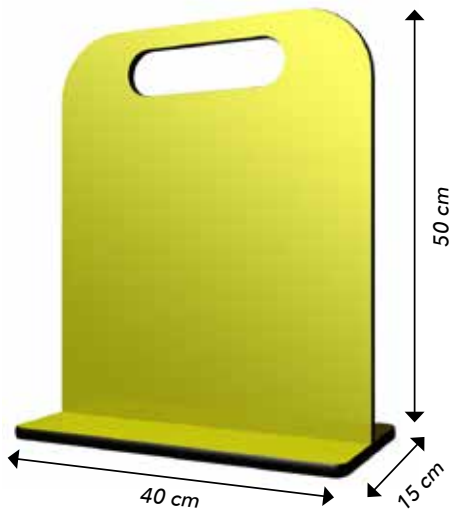

<b>I065ST20</b>	Interdit de plonger : faible profondeur	<b>I065ST35</b>	Attention Grande Profondeur
<b>I065ST22</b>	Attention Nettoyage en cours	<b>I065ST25</b>	Toboggan Interdit aux plus de 5 ans
<b>I065ST10</b>	Attention Sol glissant		
<b>I065ST11</b>	Espace jeux		

85,00 € HT

## PANNÉAUX ET PLAQUES SIGNALÉTIQUES

Texte recto  
Support PVC 5 mm  
250 x 100 mm  
Coloris ● ●



**PETIT  
BASSIN**

**I055 - Petit bassin**  
29,00 € HT

**GRAND  
BASSIN**

**I056 - Grand bassin**  
29,00 € HT

Texte recto  
Support PVC 5 mm  
600 x 100 mm  
Coloris ● ●



**PROFONDEUR 0.90 M**

**PROFONDEUR 2.00 M**

**I054 - Profondeur**  
Personnalisable  
46,00 € HT

Dimensions et textes sur mesure nous consulter



**JEUX EXTÉRIEURS INTERDITS AUX PLUS DE 8 ANS**

**PATAUGEOIRE RÉSERVÉE AUX MOINS DE 5 ANS**

**DÉFENSE DE FUMER SUR LES PLAGES**

**PHOTOS  
ET VIDEOS  
INTERDITES**

**Stade Nautique Yuri Gagarine**

Logo: **SNYG** (Stade Nautique Yuri Gagarine) and **Grand Orlyseine Bievre**

- Maillot de bain obligatoire
- Bonnet obligatoire sur les bassins intérieurs  
- Sous-vêtement interdit 
- Short de bain interdit 
- Un adulte pour trois enfants de moins de 10 ans maximum
- Interdit aux enfants de moins de 10 ans non accompagnés 
- Les enfants sont sous la responsabilité de leurs parents
- Alcool interdit 
- Chicha interdit 





## HORLOGES ET COMPTES SECONDES

NOUVEAU



### H094A - Horloge autonome

Fonctionne à l'énergie solaire et lumineuse  
Fabriquée à partir de matériaux recyclés

Visibilité jusqu'à 20 m

Ø 32 cm



600,00 € HT

Cadran et lunette en ABS  
Verre minéral  
Piles AA non incluses



### 1116AC - Horloge IP65

Visibilité jusqu'à 40 m

Ø 60 cm



205,00 € HT

### H129A - Horloge IP54

Visibilité jusqu'à 15 m

Ø 25 cm



100,00 € HT

### H129 - Horloge radiopilotée

Lunette aluminium brossé

Visibilité jusqu'à 35 m

Ø 50 cm



150,00 € HT

NOUVEAU



### H094B - Horloge affichage 5 cm 510,00 € HT

### H094C - Horloge affichage 7 cm 720,00 € HT

### H091A - Horloge/Calendrier IP54

Boîtier ABS et verre plexiglas

830 x 230 x 40 mm

1,5 kg

165,00 € HT

### H091 - Horloge radiopilotée IP54

Composite métal/plastique

Doigt de gant en option

250 x 250 x 60 mm

1,28 kg

110,00 € HT

## HORLOGES ET COMPTES SECONDES

Départ cadencé toutes les 15 s  
1 m de câble inclus Éclairage en option

NOUVEAU



### H092 - Compte-secondes IP65

Cadre aluminium laqué  
Verre plexiglas  
625 x 625 x 80 mm  
5 kg  
920,00 € HT



### H092BCEXT - Compte-secondes IP65

Cadre aluminium laqué  
Verre plexiglas  
1000 x 1000 x 120 mm  
24,5 kg  
1360,00 € HT



### H092B - Compte-secondes IP54

Sans cadre ni verre  
1000 x 1000 x 80 mm  
7 kg  
485,00 € HT



### H092A - Compte-secondes IP54

Cadre ABS  
Verre minéral  
505 x 80 mm  
3,6 kg  
650,00 € HT

### H133 - Transformateur

220V - 24V  
150,00 € HT

### H092-MOT - Moteur

170,00 € HT



### H092PC - Compte-secondes portable

Boîtier ABS et verre plexiglas  
57 x 45 x 19 cm - cadran Ø 37 cm  
3,6 kg  
460,00 € HT



**NOUVEAU**

ESSENCES DE HAMMAM			
<b>S063-2</b>	Vanille Bourbon	5 L	118,00 €
<b>S063-1</b>	Vanille Bourbon	1 L	30,00 €
<b>S065-2</b>	Mangue	5 L	118,00 €
<b>S065-1</b>	Mangue	1 L	30,00 €
<b>S061-2</b>	Lilas	5 L	138,00 €
<b>S061-1</b>	Lilas	1 L	36,00 €
<b>S028EL6</b>	Menthe	6 L	85,00 €
<b>S026B</b>	Orange Mandarine	5 L	150,00 €
<b>S026</b>	Orange Mandarine	1 L	41,00 €
<b>S025B</b>	Eucalyptus de Chine	5 L	153,00 €
<b>S025</b>	Eucalyptus de Chine	1 L	41,00 €
<b>S028B</b>	Eucalyptus Menthol	5 L	141,00 €
<b>S028</b>	Eucalyptus Menthol	1 L	38,00 €
<b>S025-6L</b>	Eucalyptus	6 L	85,00 €



**NOUVEAU**

ESSENCES DE SAUNA			
<b>S062-2</b>	Vanille Bourbon	5 L	116,00 €
<b>S062-1</b>	Vanille Bourbon	1 L	28,00 €
<b>S064-2</b>	Papaye	5 L	173,00 €
<b>S064-1</b>	Papaye	1 L	46,00 €
<b>S060-2</b>	Lilas	5 L	137,00 €
<b>S060-1</b>	Lilas	1 L	33,00 €
<b>S009B</b>	Orange Mandarine	5 L	143,00 €
<b>S009</b>	Orange Mandarine	1 L	35,00 €
<b>S002B</b>	Eucalyptus de Chine	5 L	145,00 €
<b>S002</b>	Eucalyptus de Chine	1 L	36,00 €
<b>S0035L</b>	Eucalyptus Menthol	5 L	128,00 €
<b>S003</b>	Eucalyptus Menthol	1L	30,00 €

## POÊLES ÉLECTRIQUES

**Branchement triphasé 400 V**  
**Unité de contrôle et pierres non incluses**  
**IPX4**



**HSE090400 - Poêle Senator**  
 9 kW - 8 à 14 m3  
 Fonctionne avec une unité C150  
 Capacité 40 kg de pierres  
 46,5 x 66 x 34,5 cm  
**930,00 € HT**



**Poêle Club**  
 Fonctionne avec une unité C150  
 Capacité 60 kg de pierres  
 50,5 x 70 x 43 cm

**HRKG110400**  
 11 kW - 9 à 16 m3  
**1200,00 € HT**

**HRKG135400**  
 13,5 kW - 11 à 20 m3  
**1300,00 € HT**

**AZ001 - Unité de commande C150**  
 Conçu pour les poêles 2,3 à 17 kW  
 Réglage de la température 40 et 110°C  
 Durée de fonctionnement 4 h  
 Programmable 0 à 12 h  
**658,00 € HT**

**HRHG150400**  
 15 kW - 14 à 24 m3  
**1450,00 € HT**

**S014 - Pierres volcaniques**  
 Carton de 20 kg - Ø 10-15 cm  
**30,00 € HT**



**ELS006 - Applique longue**  
230 x 330 x 155 cm  
32,00 € HT



**ELS007 - Grande applique**  
280 x 300 x 185 cm  
33,00 € HT



**ELS001 - Applique d'angle**  
230 x 210 x 230 cm  
45,00 € HT



**ELS010 - Applique d'angle**  
310 x 240 x 170 mm  
51,00 € HT



**85733 - Grille de ventilation rectangulaire**  
315 x 130 x 17 mm  
24,50 € HT



**85741 - Grille de ventilation carrée**  
315 x 140 x 130 x 17 mm  
18,00 € HT



**Poignées**  
*Nous consulter*



**S018 - Thermomètre droit**  
25,00 € HT



**S018R - Thermomètre rond**  
Ø 155 mm  
37,00 € HT



**S017 - Thermomètre hygromètre**  
Ø 155 mm  
41,00 € HT



**S036 - Bracelets journaliers**  
Usage unique  
25 x 250 mm  
Coloris nous consulter  
Lot de 1000 d'un même coloris  
75,00 € HT



**S015P-NM - Seau intérieur**  
Pour réf. S015-NM  
7,00 € HT



**S015-NM - Seau en bois**  
Bois de mélèze  
5 L  
61,50 € HT



**S015M - Seau mural en bois**  
Bois de mélèze  
5 L  
460,00 € HT



**S016 - Louche en bois**  
40 cm  
11,50 € HT





# Mobilier

Accueil et terrasse  
Bains de soleil  
Rangement fixe  
Rangement mobile  
Stratifié compact  
Utilitaires





100 % RECYCLÉS



**RE03-2 - Chaise Palma**

55 x 62 x 84 cm



25,00 € HT

**RE03-3 - Table Olot**

140 x 90 x 73 cm



99,00 € HT

**RE03-4 - Table Tossa**

Ø 86 x 73 cm



55,00 € HT



100 % RECYCLÉS



**1**  
**RE06-6 - Chaise Baku**  
 66,7 x 59,5 x 78,5 cm  
 ○ ●  
**91,00 € HT**

**2**  
**RE03-3 - Table Monaco**  
 60 x 60 x 45 cm  
 ○ ●  
**36,00 € HT**

**1 + 2**  
**RE03-3 - Set Baku/Monaco**  
 2 chaises + 1 table  
 ○ ●  
**190,00 € HT**



**RE03-8 - Chaise Play**  
 54 x 57 x 78,6 cm  
 ● ● ● ● ●  
**42,00 € HT**



**RE03-1 - Chaise Delta**  
 53,8 x 55 x 80,8 cm  
 ● ● ● ● ●  
**35,00 € HT**



**RE03-9 - Chaise Garrotxa**  
 52 x 43,6 x 89 cm  
 ●  
**29,00 € HT**



## ACCUEIL ET TERRASSE



### U018 - Parasol

Toile 180 g/m<sup>2</sup>  
8 baleines Ø 2 m  
Mât Ø 29 à 32 mm

●  
**78,00 € HT**

### U018B - Parasol

Toile 220 g/m<sup>2</sup>  
6 baleines Ø 2,5 m  
Mât Ø 35 à 38 mm

●  
**170,00 € HT**



### U021A - Pied de parasol lesté

Base ciment et tube fer époxy  
Pour mât Ø 30 à 38 mm  
36 x 26 x 30 cm  
11 kg

●  
**45,00 € HT**



### U021B - Pied de parasol à lester

13 L d'eau ou 18 kg de sable  
Pour mât Ø 18 à 33 mm  
Ø 43 x 26 cm

○  
**49,00 € HT**

## BAINS DE SOLEIL



### U001 - Bain de soleil

Inclinable sur 5 positions  
Roues arrière  
188 x 63 x 47 cm  
10,3 kg

○ ●  
**90,00 € HT**



### RE002 - Bain de soleil Sky

Inclinable sur 5 positions  
Dossier avec butée de sécurité  
Roulettes sur pieds arrière  
Cales anti-dérapantes à l'avant et à l'arrière  
195 x 77 x 37 cm  
13,7 kg

○ ● ou ○ ●  
**295,00 € HT**

## RANGEMENT FIXE

Vendus vides

PVC

Coloris



**N049-2 - Range-tapis mini**  
3 compartiments  
105 x 73 x 230 cm  
475,00 € HT



**N049-1 - Range-tapis maxi**  
6 compartiments  
200 x 70 x 230 cm  
830,00 € HT



**N049R - Range-tapis maxi**  
6 compartiments  
200 x 70 x 230 cm  
1145,00 € HT

PVC

Coloris



**N001-1 - Rayonnage 60 cm**  
100 x 60 x 195 cm 398,00 € HT  
150 x 60 x 195 cm 488,00 € HT  
200 x 60 x 195 cm 600,00 € HT

**N002 -1 - Rayonnage 50 cm**  
100 x 50 x 195 cm 314,00 € HT  
150 x 50 x 195 cm 425,00 € HT  
200 x 50 x 195 cm 520,00 € HT

Aluminium

Coloris



**Étagère à chaussures 3 niveaux**  
**R074SM** 180 x 30 x 102 cm 600,00€ H  
**R074S** 200 x 30 x 102 cm 650,00€ H



**R073 - Étagère à chaussures 5 niveaux**  
200 x 30 x 170 cm  
990,00 € HT



## RANGEMENT MOBILE

Vendus vides  
4 roues dont 2 avec frein  
PVC  
Coloris unique ●



**050CP04 - Coffre de rangement**  
120 x 70 x 94 cm  
1040,00 € HT



**N025AC - Chariot avec couvercle**  
120 x 70 x 93 cm  
970,00 € HT

**N025SC - Sans couvercle**  
120 x 70 x 93 cm  
640,00 € HT



**N026 - Chariot porte-équipements**  
21 crochets  
138 x 60 x 175 cm  
905,00 € HT



**050CP12000 - Chariot mixte**  
138 x 60 x 145 cm  
810,00 € HT

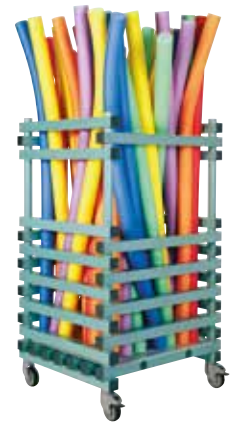

**N024R - Chariot à frites**  
80 x 70 x 135 cm  
805,00 € HT



**N066APMR - Chariot à 3 portes**  
3 compartiments  
3 cadenas inclus  
120 x 60 x 175 cm  
1999,00 € HT

**N027A - Chariot à bacs**  
138 x 60 x 180 cm  
780,00 € HT





Vendus vides  
4 roues dont 2 avec frein  
PVC  
Coloris



**N023-1 - Chariot à frites**  
100 x 50 x 96 cm  
310,00 € HT

**N024-1 - Chariot à frites**  
100 x 50 x 130 cm  
305,00 € HT



**N076-1 - Chariot à haltères**  
140 x 40 x 125 cm  
405,00 € HT



**GF031-1 - Chariot à palmes**  
6 roues dont 2 avec frein  
140 x 60 x 115 cm  
405,00 € HT



**CP46001 - Portant à gilets**  
120 x 80 x 180 cm  
790,00 € HT



**N078C-1 - Chariot à planches et ceintures**  
140 x 60 x 180 cm  
405,00 € HT



**N078G-1 - Chariot à planches et ceintures**  
140 x 60 x 180 cm  
485,00 € HT



## RANGEMENT MOBILE

Vendus vides  
Cadenas et chaîne en option  
4 roues dont 2 avec frein  
PVC  
Coloris



**N056-4 - Chariot de rangement mini**  
Sans couvercle  
100 x 87 x 80 cm  
340,00 € HT



**N056-3 - Chariot de rangement mini**  
Avec couvercle  
100 x 87 x 80 cm  
425,00 € HT



**N056-2 - Chariot de rangement maxi**  
6 roues dont 2 avec frein  
Sans couvercle  
200 x 87 x 80 cm  
525,00 € HT



**N056-1 - Chariot de rangement maxi**  
6 roues dont 2 avec frein  
Avec couvercle  
200 x 87 x 80 cm  
650,00 € HT



**N066-1 - Chariot 2 portes**  
140 x 82 x 152 cm  
650,00 € HT



**N066-2 - Chariot à 3 portes**  
140 x 82 x 205 cm  
990,00 € HT



## RANGEMENT MOBILE

Vendus vides  
4 à 6 roues dont 2 avec frein  
PVC  
Coloris



**N077-1 - Chariot à bacs**  
140 x 60 x 205 cm  
510,00 € HT



**N077-3 - Chariot 6 bacs**  
102 x 76 x 180 cm  
490,00 € HT



**N077-2 - Chariot 3 bacs**  
55 x 66 x 180 cm  
380,00 € HT



**LPCPVC002 - Chariot à bacs  
et frites centrales**  
150 x 66 x 145 cm  
975,00 € HT



**LPCPVC001 - Chariot à bacs  
et frites latérales**  
150 x 66 x 145 cm  
875,00 € HT



**N048AA - Roue avec frein**  
Ø 10 mm  
17,00 € HT



**N048A - Roue sans frein**  
Ø 10 mm  
15,00 € HT



## RANGEMENT MOBILE

Vendus vides  
Roues en option N058A



**N059 - Range noddles**  
Roues non incluses  
80 x 40 x 130 cm  
18 kg  
À l'unité  
**390,00 € HT**



**N058 - Aquatic box**  
Roues non incluses  
80 x 40 x 45 cm  
15 kg  
À l'unité  
**445,00 € HT**

Exemple de  
présentation  
avec 3 modules

## Chariot sur roues



**N038**  
60 x 40 x 40 cm  
**125,00 € HT**



**N038-2**  
60 x 40 x 80 cm  
**155,00 € HT**



**N038-3**  
60 x 40 x 120 cm  
**185,00 € HT**



**N053BR - Caisse palette 550 L**  
En PVC gris  
4 roues  
1200 x 800 x 925 mm  
Capacité 285 litres  
**425,00 € HT**



**N023GI - Panière haute**  
66,5 x 46 x 85 cm - 180 L  
**172,00 € HT**



**N038P - Plateau roulant**  
4 roues dont 2 pivotantes  
ABS et caoutchouc  
61,6 x 41,6 x 17,2 cm  
**62,00 € HT**

## STRATIFIÉ COMPACT

Stratifié compact 10 mm  
Intérieur personnalisable  
Pieds en option  
Coloris

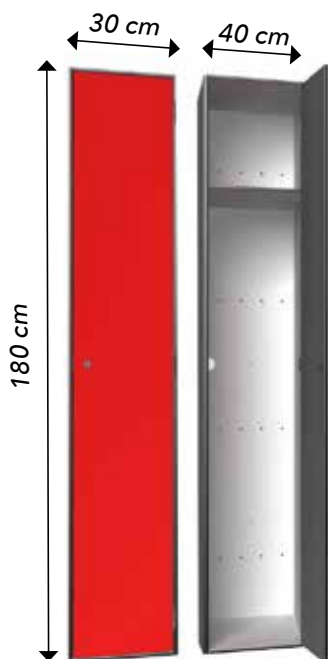

**RCC1P - Armoire maître-nageur**  
180 x 30 x 50 cm  
600,00 € HT

**RCC1PL - Armoire maître-nageur**  
180 x 40 x 50 cm  
650,00 € HT

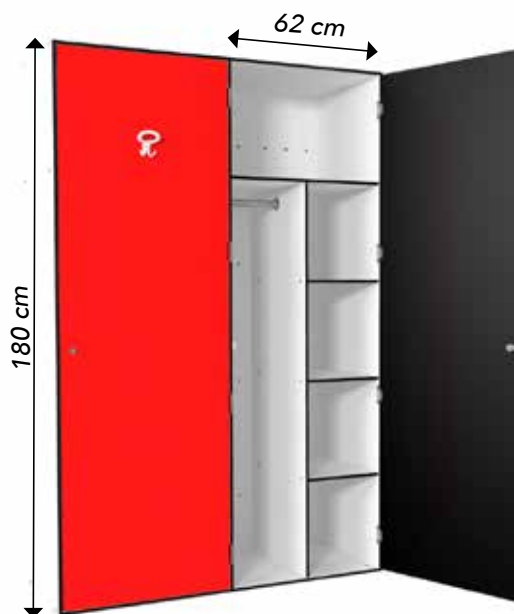

**RCC1PMN - Armoire maître-nageur**  
180 x 60 x 50 cm  
980,00 € HT



**N081A - Armoire de bureau**  
6 étagères  
180 x 120 x 40 cm  
1050,00 € HT



**N081B - Armoire de bureau basse**  
4 étagères  
100 x 120 x 40 cm  
800,00 € HT



**N079F - Bureau maître-nageur**  
Niche avec 1 étagère  
Pieds en option  
120 x 70 x 72 cm  
575,00 € HT



## STRATIFIÉ COMPACT

Stratifié compact 10 mm  
Pieds en option

Coloris 

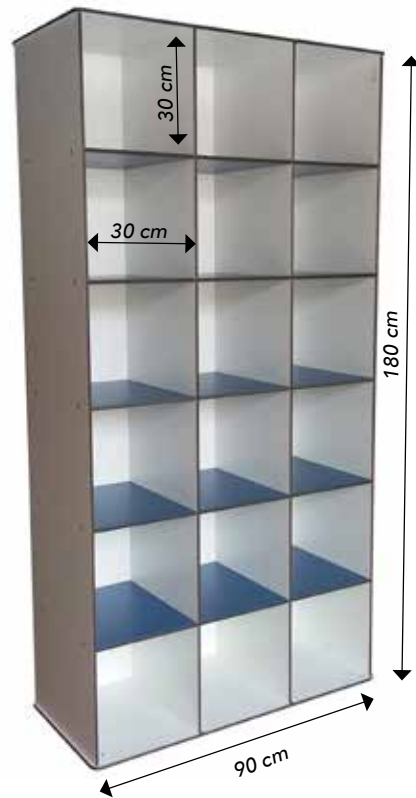

### N08012C - Étagère 12 cases

100 x 75 x 30 cm

650,00 € HT

### N08016C - Étagère 16 cases

100 x 100 x 30 cm

775,00 € HT

### N08018C - Étagère 18 cases

180 x 90 x 35 cm

990,00 € HT



### N08020C - Étagère 20 cases

4 roues dont 2 avec frein

158 x 125 x 52 cm

1350,00 € HT

### N08025C - Étagère 25 cases

4 roues dont 2 avec frein

158 x 156 x 52 cm

1500,00 € HT

### N08040C - Étagère 40 cases

200 x 125 x 30 cm

1500,00 € HT



### N040STRAT1 - Banc 12 cases

4 roues

150 x 40 x 40 cm

590,00 € HT

### N040STRAT6 - Banc 6 cases

4 roues

100 x 40 x 40 cm

500,00 € HT

## STRATIFIÉ COMPACT

Stratifié compact 10 mm

Coloris 



### N040STRAT - Banc coffre

4 roues  
150 x 40 x 40 cm  
600,00 € HT

### Serrures Ojmar en option p. 81



#### CA001 - Serrure came batteuse droite

Barillet à paillettes  
2 clés plates incluses  
18,50 € HT



#### R001 - Pied de cabine

Réglable 14 à 17 cm  
Nylon option inox  
Coloris   
25,00 € HT



#### CA009 - Serrure cadennassable droite

Came et cadenas non inclus  
15,00 € HT



#### R001M - Pied de cabine

Réglable 9 à 13 cm  
Nylon option inox  
Coloris   
30,00 € HT

#### R001CA - Pied de casier

Aluminium  
14 à 17 cm  
27,00 € HT

## UTILITAIRES



#### U007 - Barrière V1200

126 x 102 x 5 cm  
Pieds 48 cm  
6,5 kg  
  
90,00 € HT



#### U007 - Barrière V2000

198 x 102 x 5 cm  
Pieds 55,5 cm  
9,2 kg  
  
102,50 € HT



# Vestiaires

Casiers et accessoires  
Bancs et patères  
Serrures et accessoires  
Sèche-cheveux  
Tables à langer et chaises hautes



## CASIERS ET ACCESSOIRES

Stratifié compact 10 mm

Serrures en option p. 81

Pieds en option

Coloris

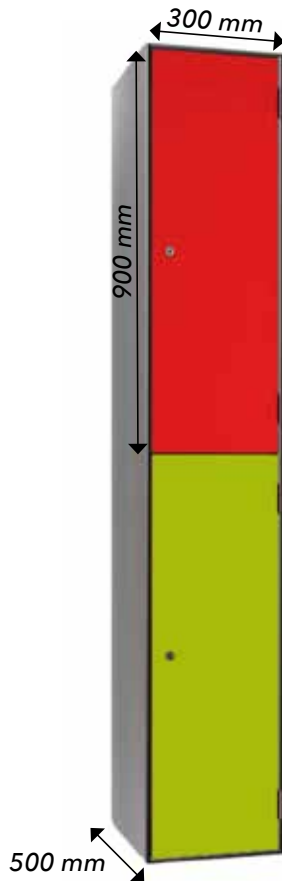

### Colonne avec 2 casiers

#### RCC2P

180 x 30 x 50 cm

475,00 € HT

#### RCC2P400

180 x 40 x 50 cm

550,00 € HT

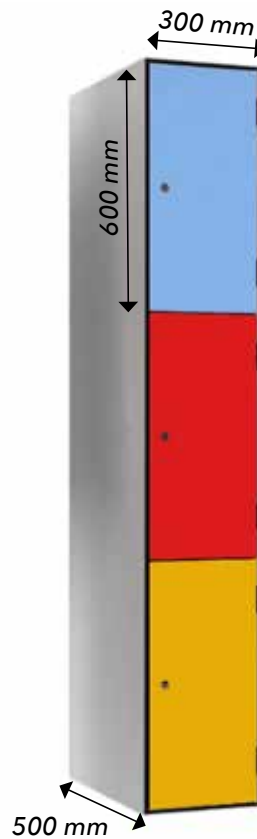

### Colonne avec 3 casiers

#### RCC3P

180 x 30 x 50 cm

500,00 € HT

#### RCC3P400

180 x 40 x 50 cm

550,00 € HT

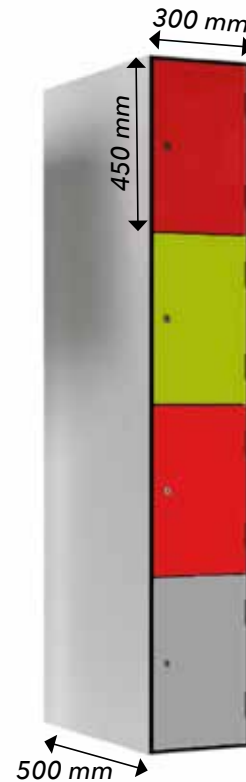

### Colonne avec 4 casiers

#### RCC4P

180 x 30 x 50 cm

550,00 € HT

#### RCC4P400

180 x 40 x 50 cm

575,00 € HT



### R001CA - Pied de casier

Aluminium

14 à 17 cm

27,00 € HT



FABRIQUÉ  
EN FRANCE



### R065FB - Miroir plat

Fibre de bois et plexi+

366 x 466 x 19 mm

289,00 € HT

## CASIERS ET ACCESSOIRES

Nylon option inox

Coloris ○ ● ●



**R001 - Pied de cabine**  
Réglable 14 à 17 cm  
25,00 € HT



**R001M - Pied de cabine**  
Réglable 9 à 13 cm  
30,00 € HT



**R004EN - Équerre murale**  
12,00 € HT



**R044PIN10 - Pince murale**  
24,00 € HT



**R003NOBL - Verrou à voyant**  
30,00 € HT



**R002 - Bouton double**  
Vis incluses  
Ø 50 mm  
25,00 € HT



**R004 - Paumelle droite**  
**R004G - Paumelle gauche**  
25,00 € HT



**R064 - Charnière**  
Inox  
9,50 € HT



**R064R - Charnière avec ressort**  
Inox  
15,00 € HT



**CA008 - Gâche de serrure**  
Inox  
5,00 € HT



**H068CF - Clé pour verrou**  
Carré de 8 mm  
Inox  
12,00 € HT





## BANCS ET PATÈRES

Structure tubulaire inox électropoli 30 x 30 mm  
Lames en stratifié compact 12 mm  
Vis inox

Coloris 



### Banc simple 2 fonctions

**N085/140**

140 x 36 x 46 cm  
290,00 € HT

**N085/180**

185 x 36 x 46 cm  
390,00 € HT

**N085/200**

200 x 36 x 46 cm  
430,00 € HT

**N085/280**

280 x 36 x 46 cm  
570,00 € HT



### Banc double 3 fonctions

**N085D/140**

140 x 77 x 82 cm  
650,00 € HT

**N085D/185**

185 x 77 x 82 cm  
860,00 € HT

**N085D/200**

200 x 77 x 82 cm  
950,00 € HT

**N085D/280**

280 x 77 x 82 cm  
1280,00 € HT



### Banc double 4 fonctions

**N085D/140**

140 x 77 x 176 cm  
790,00 € HT

**N083D/185**

185 x 77 x 176 cm  
1050,00 € HT

**N083D-200**

200 x 77 x 176 cm  
1150,00 € HT

**N083D/280**

280 x 77 x 176 cm  
1550,00 € HT



### RSBT - Banc mural

280 cm maximum par section  
Supports inclus  
140,00 € HT le mètre linéaire

### RSBTP1 - Support de banc

Inox 316  
Structure tubulaire 50 x 30 mm  
85,00 € HT



## BANCS ET PATÈRES

PVC

Coloris ○ ●



### N009-1 - Banc modulaire

40 x 45 cm

● uniquement

150,00 € HT le mètre linéaire



### Banc simple LPCPVC

100 x 40 x 50 cm

140,00 € HT

150 x 40 x 50 cm

210,00 € HT

200 x 40 x 50 cm

230,00 € HT



### Banc simple avec rangement chaussures N009EC

100 x 40 x 50 cm

140,00 € HT

150 x 40 x 50 cm

170,00 € HT

200 x 40 x 50 cm

200,00 € HT



### Banc simple avec patères et rangement chaussures

#### N069-100

100 x 56 x 185 cm

300,00 € HT

#### N069-200

200 x 56 x 185 cm

490,00 € HT

#### N069-150

150 x 56 x 185 cm

430,00 € HT



### Banc double avec patères et rangement

#### N070

100 x 88 x 185 cm

385,00 € HT

200 x 88 x 185 cm

610,00 € HT

150 x 88 x 185 cm

515,00 € HT



## BANCS ET PATÈRES

Stratifié compact



### R062M - Lisse porte patère

6 patères PVC  
100 x 10 cm  
75,00 € HT



### R061M - Lisse porte patère

4 patères inox  
16 cm de haut  
Au mètre linéaire  
85,00 € HT



### R055 - Patère

Acier époxy  
140 x 40 mm  
○  
8,00 € HT

### R055-1

●  
8,00 € HT



### NL002 - Patère

Nylon  
145 x 23 x 80 mm  
○  
19,00 € HT

### NL002N

●  
19,00 € HT



### N043 - Patère

double tête  
Nylon  
78 x 80 x 42 mm  
○  
9,00 € HT



### N016N-1 - Patère

Nylon  
Ø 53 x 37 mm  
○ ● ●  
14,00 € HT



### R0010 - Patère

Aluminium  
51,5 x 18 x 65 mm  
○ ● ●  
8,00 € HT



### N016A - Patère

Inox  
9,00 € HT

## SERRURES ET ACCESSOIRES

### Standard Ojmar



#### Serrure à pièce standard Ojmar

Canon interchangeable  
2 clés standard incluses

**Q001NM**  
Droite  
47,00 € HT

**Q002NM**  
Gauche  
47,00 € HT



#### Serrure à carte/pièce standard

Canon interchangeable  
2 clés standard incluses

**Q005NM**  
Droite  
66,00 € HT

**Q006NM**  
Gauche  
55,00 € HT



**Q013 - Clé Standard**  
8,40 € HT



**Q014 - Clé Pass**  
10,00 € HT



**Q015 - Clé Extraction**  
10,00 € HT



**Canon standard interchangeable**  
2 clés standard incluses

**Q009**  
Droite  
30,00 € HT

**Q010**  
Gauche  
30,00 € HT

### Sûreté Ojmar



#### Serrure à pièce sûreté Ojmar

Canon interchangeable  
2 clés sûreté incluses

**Q003NM**  
Droite  
55,50 € HT

**Q004NM**  
Gauche  
55,50 € HT



#### Serrure à carte/pièce sûreté

Canon interchangeable  
2 clés sûreté incluses

**Q007-NM**  
Droite  
74,00 € HT

**Q008NM**  
Gauche  
74,00 € HT



**Q016 - Clé Sûreté**  
10,80 € HT



**Q017 - Clé Pass**  
12,50 € HT



**Q018 - Clé Extraction**  
12,50 € HT



**Canon sûreté interchangeable**  
2 clés sûreté incluses

**Q011**  
Droite  
33,50 € HT

**Q012**  
Gauche  
33,50 € HT



#### Q052 - Jetons métalliques

Lot de 500 349,00 € HT  
Lot de 1000 698,00 € HT



## BRACELETS DE VESTIAIRE ET POCHE DE PROTECTION

NOUVEAU



### Q054-1 - Bracelet LPC

Non compatible avec les poches Q048

Cuir JafTex

330 x 12 x 1,8 mm



Sans numéro

1,50 € HT

Numéro consécutif

3,20 € HT

Numéro non consécutif 3,50 € HT



### Q030 - Bracelet Ojmar non numéroté

Poche de protection ABS

Polyuréthane

Bouche inox

265 x 2 x 15 mm



4,60 € HT

### Q030N - Bracelet Ojmar numéroté

5,50 € HT



### Q048 - Poche de protection non numérotée

Non compatible avec les bracelets Q054-1

1,65 € HT



### Q048NO - Poche de protection numérotée

Non compatible avec les bracelets Q054-1

1,80 € HT

PVC  
25 x 15 x 10 mm  
Coloris ●



### Q038B - Poche de protection

Ojmar non numérotée

3,80 € HT



### Q038 - Poche de protection

Ojmar numérotée

3,90 € HT

ABS  
35 x 20 x 10 mm  
Coloris ●



### Q050 - Plaque

Aluminium

1,70 € HT



### Q039 - Rivet de fixation

Mâle/Femelle

0,40 € HT

### Q039-1 - Rivet Ojmar

Mâle/Femelle

0,80 € HT

## SÈCHE – CHEVEUX

Tarifs nous consulter

Pièces détachées modèles Vendaal et Beluga nous consulter

**NOUVEAU**



Rouge rubis



Bleu azur



Gris souris  
nacré



Aluminium  
blanc



Gris anthracite



Blanc pur

### Sèche cheveux Beluga

6 coloris

2 modèles :

Fixe et sur rail

Coloris du rail :

● Aluminium blanc

○ Blanc pur

Miroir en option



Moteur



Carte  
électronique



Résistance



Verrin

## TABLES À LANGER ET CHAISES HAUTES



### R019 - Chaise haute

6 mois à 3 ans

59 x 50 x 75,5 cm

3,9 kg

● ● ou ● ●

300,00 € HT



### R019 - Table à langer

Matelas non inclus

Roues en option

PVC

100 x 65 x 95 cm

○ ●

300,00 € HT



### R016 - Table à langer murale

Modèle horizontal

87,2 x 10,2 x 51 cm

9 kg

460,00 € HT



### R015 - Table à langer murale

Modèle vertical

86 x 55 x 69 cm

12 kg

660,00 € HT



### R020TEM - Matelas à langer

82 x 57 cm

45,00 € HT



# Sécurité et surveillance

Matériels de surveillance  
Matériels de sauvetage  
Matériels de premiers secours  
Matériels d'urgence  
Accessibilité PMR



## CHAISES DE SURVEILLANCE

Polypropylène  
Coloris unique ●

1  
↓



2  
↓



3 →



1  
**O002-8 - Parasol**  
175,00 € HT

2  
**O002-6 - Plateau suspendu**  
130,00 € HT

3  
**O002-7 - Coussin d'assise et de dossier**  
115,00 € HT



**O002-5 - Kit roues fixes**  
140,00 € HT



## CHAISES DE SURVEILLANCE

Polypropylène  
Coloris unique ●



### O002-1 - Chaise de surveillance

1 marche  
Hauteur 135 cm  
Empâtement 87,5 cm  
Assise 80 cm  
**1460,00 € HT**



### O002-2 - Chaise de surveillance

2 marches  
Hauteur 170 cm  
Empâtement 104 cm  
Assise 116 cm  
**1755,00 € HT**



### O002-3 - Chaise de surveillance

3 marches  
Hauteur 206,5 cm  
Empâtement 120 cm  
Assise 156 cm  
**1955,00 € HT**



### O002-4 - Chaise de surveillance

4 marches  
Hauteur 243 cm  
Empâtement 136 cm  
Assise 188 cm  
**2515,00 € HT**

SÉCURITÉ  
ET SURVEILLANCE

Matériels de surveillance ■ Matériels de sauvetage ■ Matériels de premiers secours ■ Matériels d'urgence ■ Accessibilité PMR



## CHAISES DE SURVEILLANCE

Marches antidérapantes  
Pièces détachées sur demande



FABRIQUÉ  
EN FRANCE



### CLEAN002 - Chaise de surveillance

3 marches  
2 roues  
Inox 316L poli  
100 cm  
2500,00 € HT



### O053M - Chaise de surveillance

3 marches  
2 roues  
Inox 316 électropoli  
100 cm  
930,00 € HT



### O053 - Chaise de surveillance

5 marches  
1 crochet  
2 roues  
Inox 316 électropoli  
165 cm  
1075,00 € HT



### O001 - Chaise de surveillance

5 marches + 1 plateforme  
2 roues  
Inox 304  
185 cm  
2160,00 € HT



### O004 - Chaise de surveillance

5 marches  
Aluminium  
200 cm  
650,00 € HT



### O053MA - Marche

Compatible avec O053 et O053M  
Polyester  
43,00 € HT



### O001SP - Support de parasol

Incompatible avec O004  
Inox  
112,00 € HT



### O001B - Support de bouée

5 marches  
Aluminium  
200 cm  
57,00 € HT

## MIROIRS DE SURVEILLANCE

Système de fixation inclus  
 Traitement anti-âge et anti-vandalisme  
 Autres dimensions et personnalisation sur demande



**NOUVEAU**



**R065R - Miroir rond**  
 Ø 60 cm  
 575,00 € HT



**R065600 - Miroir rectangulaire**  
 60 x 80 cm  
 550,00 € HT



**R065GT - Miroir sans cadre**  
 100 x 80 cm  
 650,00 € HT



Exemple de personnalisation

## ÉQUIPEMENTS DE COMMUNICATION



**O021 - Porte voix avec micro**  
 Micro intégré  
 Puissance 30 W  
 Batterie rechargeable  
 1 kg  
 154,00 € HT



**O020W - Sifflet Wizzball**  
 13,80 € HT



**O020B - Sifflet sans bille**  
 Cordon inclus  
 2,80 € HT

**SÉCURITÉ  
 ET SURVEILLANCE**

Matériels de surveillance ■ Matériels de sauvetage ■ Matériels de premiers secours ■ Matériels d'urgence ■ Accessibilité PMR



IP57



### O050G15 - Talkie-walkie Midland G15 Pro

32 canaux PMR446 (dont 16 préprogrammés)  
50 tons CTCSS + 105 codes DCS

Side tone, Scan, Moniteur, VOX

Économie de batterie automatique

Étanchéité IP67

Inclus :

- 1 émetteur-récepteur
- 1 clip ceinture
- 1 micro-écouteur
- 1 socle de charge
- 1 transformateur
- 1 batterie Li-ion 7,4 V
- 1 dragonne

155,00 € HT

### Accessoires Midland G154 Pro



### O050G15-1 - Base de recharge

170,00 € HT



### O050G15-2 - Batterie

45,00 € HT



### O050G15-3 - Socle de charge

40,00 € HT

NOUVEAU

IPX2



### O050XT50 - Talkies-walkies XT50 Pro

85 canaux 569 LPD + 16 PMR446°

38 tons CTCSS en TX et RX + 83 tons DCS

Side tone, Scan, Moniteur, VOX

Jusqu'à 12 heures d'autonomie

Distance jusqu'à 8 km

Étanchéité IPX2

102 x 49 x 30 mm

Inclus :

- 2 émetteurs-récepteurs
- 2 clips ceinture
- 2 Packs de batterie 700 mAh
- 2 écouteurs MA21-Li
- 2 colliers de cou
- 1 câble de recharge USB

155,00 € HT

NOUVEAU

IPX4



### O050XT70 - Talkies-walkies XT70 Pro

32 canaux PMR446 (16+16 préprogrammés) + 69 LPD

38 tons CTCSS en TX et RX + 104 tons DCS

Side tone, Scan, VibraCALL, Moniteur, VOX

Jusqu'à 12 heures d'autonomie

Distance jusqu'à 12 km

Étanchéité IPX4

120 x 53 x 35 mm

Inclus :

- 2 émetteurs-récepteurs
- 2 batteries 700 mAh Ni-MH
- 2 clips ceinture
- 2 écouteurs MA21-Li
- 2 colliers de cou
- 1 chargeur de table
- 1 adaptateur mural

170,00 € HT

## PERCHES ET BOUÉES DE SAUVETAGE



**O019 - Perche**  
Aluminium  
Ø 30 mm  
Au mètre linéaire  
2 embouts inclus  
● ○ ● ● ●  
**16,00€**



**O0480 - Système de fixation pour perche**  
PVC  
**9,00 € HT**



**M058 - Embout couvrant**  
Ø 30  
**3,30 € HT**



**O028F - Bouée de sauvetage avec sangle**  
105 x 15 x 8 cm  
**107,00 € HT**

## GILETS DE SAUVETAGE



**Gilet de sauvetage**  
**63938** 30/40 kg ● sangle ● **58,00 € HT**  
**63939** 40/60 kg ● sangle ● **61,00 € HT**  
**63940** 60/80 kg ● sangle ● **65,00 € HT**  
**63941** > à 80 kg ● sangle ● **65,00 € HT**



**Gilet de sauvetage pour enfant**  
**836334S** 2/3 ans 15/18 kg **35,00 € HT**  
**836334M** 3/6 ans 18/30 kg **38,00 € HT**

## MANNEQUINS



**O012 - Ferron**  
Adulte 8 kg  
**599,00 € HT**

**O013 - Ferron**  
Scolaire 4 kg  
**539,00 € HT**



**O014 - Entraînement**  
Adulte 8 kg  
**230,00 € HT**

**O015 - Entraînement**  
Scolaire 4 kg  
**225,00 € HT**



## APPAREILS DE DIAGNOSTICS



**O056 - Oxymètre de pouls**  
55,00 € HT



**O058P - Tensiomètre de poignet**  
65,00 € HT



**O054I - Thermomètre infrarouge**  
55,00 € HT



**O054 - Thermomètre auriculaire**  
55,00 € HT

## IMMOBILISATION ET TRANSFERT



**O032 - Brancard pliable**  
Aluminium  
208 x 54,5 x 13,5 cm  
4,7 kg  
Charge admissible 159 kg  
158,00 € HT



**O041 - Plan dur**  
Polyéthylène  
184 x 45 x 7 cm  
7,5 kg  
Charge admissible 159 kg  
170,00 € HT



**O043 - Sangle de maintien**  
Adulte  
25,50 € HT

**O043E - Sangle de maintien**  
Enfant  
22,50 € HT



**O044 - Immobilisateur de tête**  
Compatible radiographie, IRM et CT-Scan  
Vinyle  
43 x 26 x 12 cm  
100,00 € HT



**P029J - Kit de 5 attelles**  
Sac de transport inclus  
1 jambe 580 x 100 mm  
1 bras 500 x 40 mm  
1 avant-bras 400 x 40 mm  
1 poignet 250 x 50 mm  
1 coude/cheville 230 x 50 mm  
220,00 € HT



**P014 - Kit de 6 colliers cervicaux**  
Sac de transport inclus  
6 tailles différentes  
135,00 € HT



**P012 - Collier cervical**  
Adulte  
Réglable sur 4 positions  
19,50 € HT

**P013 - Collier cervical**  
Enfant  
Réglable sur 4 positions  
26,00 € HT

## MOBILIER D'INFIRMERIE

Stratifié compact et plexiglas  
Pieds en option p 73



**R102 - Armoire à pharmacie**  
Murale  
40 x 15 x 45 cm  
180,00 € HT



**R100 - Armoire à pharmacie**  
1 porte  
180 x 40 x 50 cm  
600,00 € HT



**R101 - Armoire à pharmacie**  
2 portes  
180 x 78 x 50 cm  
900,00 € HT



**O034 - Lit d'infirmier**  
Acier laqué époxy et simili cuir  
190 x 60 x 81 cm  
Charge admissible 150 kg  
538,00 € HT



**O039T - Tabouret à roulette**  
52 à 71 x Ø 50 cm  
Assise Ø 38,5 x 4 cm  
Charge admissible 130 kg  
140,00 € HT



**O033E - Marchepied 1 marche**  
Acier laqué époxy  
40 x 24,5 x 22 cm  
Charge admissible 150 kg  
79,00 € HT



**O033 - Marchepied 2 marches**  
Acier laqué époxy  
40 x 24,5 x 34 cm  
Charge admissible 150 kg  
125,00 € HT

SÉCURITÉ  
ET SURVEILLANCE



## ASPIRATION



### P022 - Aspirateur de mucosité manuel

Flacon 300 ml  
1 sonde adulte 17 mm  
1 sonde enfant 9 mm  
Sac inclus  
87,00€ HT

**P022FL - Flacon de recharge**  
16,00 € HT

**P022S - Sondes adulte et enfant de recharge**  
8,00 € HT

## OXYGÉNATION



### P009- Insufflateur à usage unique

T5 - Adulte  
T3 - Enfant  
T1 - Nourrisson  
À l'unité  
20,00 € HT



### P009F - Filtre antiviral et antibactérien

À l'unité  
3,00 € HT



### P021 - Masque de poche

300 ml  
À l'unité  
14,00 € HT



### P021U - Masque insufflateur à usage unique

Taille 0 - Nouveau-né	Ø 15 mm extérieur
Taille 1 - Bébé	Ø 15 mm extérieur
Taille 2 - Enfant	Ø 22 mm extérieur
Taille 3 - Adolescent	Ø 22 mm intérieur
Taille 4 - Adulte	Ø 22 mm intérieur
Taille 5 - Adulte fort	Ø 22 mm intérieur

Sans phtalates  
À l'unité  
3,50 € HT



### P023C - Kit de 8 canules de Guedel

1 modèle par taille de T000 à T5  
8 tailles différentes de 40 à 110 mm  
Dissociables par identification-couleur  
20,00 € HT





**P036 - Sac de secours Stratus**

Compatible bouteille 5 L  
Fond antidérapant  
Sangles réglables par velcro  
Mousse de protection dorsale  
34 x 70 x 21 cm - 50 L  
2,5 kg



715,50 € HT



**P034A - Sac de secours Nimbus II**

Compatible bouteille 5 L  
Fond antidérapant  
Sangles réglables par velcro  
Mousse de protection dorsale  
26 x 70 x 21 cm - 34 L  
2,3 kg



327,50 € HT



FABRIQUÉ  
EN FRANCE



**OXY1034 - Sac d'oxygénothérapie Coyote**

Fond doublé en Hypalon (résiste au feu et aux acides)  
Anneau de treuillage et d'hélicotreuillage  
Sangle porte détecteur de gaz et sangle porte-matériel  
50 x 75 x 28 cm - 95 L  
4,2 kg



845,00 € HT



**OXY1035 - Sac d'oxygénothérapie Coyote**

Fond doublé en Hypalon (résiste au feu et aux acides)  
Anneau de treuillage et d'hélicotreuillage  
PVC  
50 x 75 x 28 cm  
4,2 kg



900,00 € HT



**OXY1042 - Sac d'oxygénothérapie Decal Scalp**

Compatible bouteille de 2 ou 5 L  
Tissu Polyamide 1680 D, imperméable, antistatique et bactériostatique  
Fond doublé en Hypalon (résiste au feu et aux acides)  
75 x 46 x 35 cm - 57 L  
3,7 kg



845,00 € HT



**P036A - Trolley pour sac de secours**

Compatible avec Stratus et Nimbus II  
Équipé d'une sangle de maintien  
Aluminium  
64 à 105 x 40 x 17 cm  
1,5 kg  
Charge admissible 40 kg  
40,00 € HT



**OPT1102 - Trolley pour sac de secours**

Compatible avec Coyote et Decal Scalp  
Aluminium et plastique  
60 à 110 x 32 x 323 cm  
1,5 kg  
40,00 € HT



**P037MS - Fauteuil de mise à l'eau manuelle avec contre-poids**

Charge admissible 136 kg  
Inox peint et polypropylène  
75 x 160 x 165 cm  
365 kg  
**7900,00 € HT**



**P037 - Fauteuil de mise à l'eau sur batterie BluOne**

Temps de descente 23 s  
Temps de montée 17 s  
Charge admissible 110 kg  
Acier zingué et peinture époxy  
120 x 540 x 125 cm  
120 kg  
**9200,00 € HT**



**P038-1 - Fauteuil de mise à l'eau sur batterie Ecpool**

Temps de descente 20 s  
Temps de montée 25 s  
Charge admissible 136 kg  
Inox et peinture époxy  
182 x 59 x 156 cm  
135 kg  
**7500,00 € HT**



**CLEAN007 - Fauteuil de mise à l'eau hydraulique**

Charge admissible 120 kg  
Inox 316L  
182 x 59 x 156 cm  
55 kg  
**6200,00 € HT**



**DAKOTAPISC - Fauteuil de douche Dakota**

Charge admissible 110 kg  
Inox 304L, roues nylon et toile Batyline®  
100 x 65 x 100 cm - roues Ø 12,5 mm  
15 kg  
**2300,00 € HT**



**820210/212 - Fauteuil roulant Bathmobile**

Seau d'aisance inclus  
Charge admissible 130 kg  
Inox 304L, roues nylon et assise caoutchouc  
110 x 66 x 100 cm  
4,5 kg  
**850,00 € HT**



**P041AX - Siège de douche Easyroller**

Charge admissible 150 kg  
Plastique  
82,5 x 67 x 105 cm  
17 kg  
**1985,00 € HT**



**P041BS - Fauteuil roulant**

Charge admissible 150 kg  
Accoudoir amovible  
Inox et roues polypropylène  
98,5 x 70,5 x 106 cm  
Assise largeur 50 cm  
18 kg  
● ● ● ●  
**2500,00 € HT**



## TABOURETS ET SIÈGES DE DOUCHE



### P042A - Siège de douche relevable standard

364 x 382 x 500 mm - Ø 25 mm



186,00 € HT



### P042A-1 - Siège de douche relevable standard

364 x 382 x 500 mm - Ø 25 mm



285,00 € HT



### P042A1 - Siège de douche relevable large

585 x 360 x 500 mm



302,00 € HT



### 047650 - Tabouret de douche standard

335 x 385 x 485 mm - Ø 30 mm  
150,00 € HT

### 047678 - Tabouret de douche large

490 x 330 x 650 mm - Ø 30 mm  
Assise 470 mm  
246,00 € HT

### P042AS - Siège de douche à suspendre

317 x 503 x 367 mm  
258,00 € HT

Coloris ○

## TABOURETS ET SIÈGES DE DOUCHE

Coloris

**NOUVEAU**



**P042N-1 - Siège de douche relevable**

412 x 512 x 219 mm  
302,00 € HT



**P042N-2 - Siège de douche relevable avec dossier**

412 x 512 x 505 mm  
302,00 € HT



**P042N-3 - Siège de douche relevable avec dossier et accoudoir**

584 x 512 x 505 mm  
302,00 € HT

**SÉCURITÉ  
ET SURVEILLANCE**

## BARRES D'APPUI



Charge admissible 150 kg  
Avec embases  
Tube elliptique 38 x 25 mm  
Nylon  
Coloris

**NOUVEAU**



**P047-1 - Barre droite**

30 cm 84,00 € HT  
40 cm 95,00 € HT  
50 cm 103,00 € HT  
60 cm 109,00 € HT  
80 cm 117,00 € HT  
100 cm 131,00 € HT



**P043 - Barre relevable**

60 cm - Ø 30 mm  
230,00 € HT

**NOUVEAU**



**P051 - Barre d'appui 90°**  
172,00 € HT

**NOUVEAU**



**P050 - Barre coudée 135°**  
170,00 € HT

**Accessibilité PMR**

Matériels de surveillance ■ Matériels de sauvetage ■ Matériels de premiers secours ■ Matériels d'urgence



# Entretien et régulation

Produits chimiques  
Matériels d'entretien  
Appareils de mesure  
Appareils de dosage  
Matériels de filtration  
Matériels de rétention



**A010B - Adilon B**

Liquide alcalin concentré non moussant  
Nettoie et dégraisse les salissures  
Adapté au nettoyage haute pression  
10 L  
50,00 € HT



**A017B - Adilon S**

Liquide acide concentré peu moussant  
Nettoie et détartre les salissures et les  
dépôts calcaires  
Adapté au nettoyage haute pression  
10 L  
45,00 € HT



**A012B - Décalcit Super**

Liquide acide concentré surpuissant  
Élimine les dépôts tenaces de  
calcaire sur les parois et le fond des  
bassins  
10 L  
49,00 € HT



**A013B - Demykosan Bact+**

Liquide nettoyant désinfectant  
Sans rinçage  
Pour les sols et surfaces  
10 L  
85,00 € HT



**A020B - Bordnet gel S**

Gel acide concentré  
Élimine les dépôts tenaces sur  
les lignes de nage  
Idéal en cas d'eau calcaire  
Convient à tous les revêtements  
de piscine  
10 L  
60,00 € HT



**S013 - Nettoyant Sauna**

10 L  
65,00 € HT



**S030 - Nettoyant Hammam**

10 L  
55,00 € HT

## PRODUITS DE TRAITEMENT DE L'EAU

FDS sur demande  
Produits français nous consulter

### Filtration



**B008 - Détartrant filtre liquide**  
5 L  
15,50 € HT



**B006 - Floculant liquide**  
20 L (24 kg)  
50,00 € HT



**B025 - pH moins 55%**  
20 L (29 kg)  
40,00 € HT



**B002 - pH plus**  
20 L (27 kg)  
44,00 € HT

### Désinfection



**B013G - Neutralisant granulé Chlorkill**  
5 kg  
40,00 € HT



**B016 - Hypochlorite de calcium GR70 granulé non stabilisé**  
25 kg  
160,00 € HT



**B015 - Chlore granulé GR56 stabilisé**  
25 kg  
158,00 € HT



**B013 - Neutralisant chlore liquide**  
20 L (25 kg)  
43,00 € HT

### Désinfection



**B019 - Chlore galet 90/250 stabilisé**  
25 kg  
170,00 € HT



**B014 - Stabilisant granulé**  
25 kg  
155,00 € HT



**B012 - Hypochlorite de sodium**  
Avec séquestrant pour limiter la cristallisation  
20 L (25 kg)  
42,50 € HT





## MANCHES ET ACCESSOIRES

Fixation à clip  
Fixation à vis papillon en option



**F013 - Tuyau flottant**  
Ø 38  
8, 10, 12, 15, 20, 25, 50 m  
3,00 € HT



**F022 - Télescopique standard à clip**  
Aluminium  
2,4 à 4,8 m  
38,00 € HT



**F001 - Épuisette de fond**  
11,00 € HT



**F003 - Épuisette de surface**  
10,00 € HT



**F007 - Éponge pour ligne d'eau**  
3,10 € HT



**F008 - Brosse manuelle**  
8,00 € HT



**F011 - Brosse droite**  
165 mm  
9,00 € HT



**F012 - Brosse d'angle**  
3,60 € HT



**F009 - Brosse de paroi**  
13,00 € HT



**F005 - Brosse courbée**  
7,00 € HT



**F083 - Tête de balai Fairlocks**  
Plastique, articulé, brosse centrale réglable et remplaçable déflecteur d'aspiration lesté  
48 cm  
Ø 38 int.  
Ø 50 ext.  
245,00 € HT



**F024 - Tête de balai inox**  
45 cm  
Ø 38 int.  
Ø 50 ext.  
445,00 € HT

## CENTRALE DE NETTOYAGE



### C155 - Centrale de Nettoyage

Nettoie et désinfecte par pulvérisation les sols et les surfaces  
 Se raccorde directement à un robinet  
 Fonctionne sans alimentation électrique ni air comprimé  
 Mélange le produit chimique avec l'eau par système Venturi  
 Température de travail maximale 50°C  
 Bidon 5 L  
 Tuyau 25 m  
 Raccord int. Ø 38 mm  
 Raccord ext. Ø 50 mm  
**500,00 € HT**

## PROTECTION DE LA PERSONNE



**B017 - Masque de protection**  
 Cartouche non incluse  
**105,00 € HT**

**B018 - Cartouche T12 ABE2**  
**20,00 € HT**



**B017T - Tablier de protection**  
**54,00 € HT**



**EUK - Bottes de sécurité PVC**  
 39 à 47  
**55,00 € HT**



**B026R - Gants en nitrile**  
 Tailles 8/9/10  
 33 cm,  
**2,40 € HT**



**B026A - Gants en PVC**  
 PVC trempé et vulcanisé  
 sur support jersey  
 40 cm  
**15,00 € HT**



**F034 - Surchaussures jetables**  
 Taille unique  
 50 paires  
**7,50 € HT**



**F033LU - Surchaussures jetables Deluxe**  
 Taille unique  
 200 paires  
**205,00 € HT**



**F033 - Surchaussures PVC**  
 Taille unique  
 La paire  
**15,00 € HT**



## THERMOMÈTRES, HYGROMÈTRES ET PH-MÈTRES



**D054 - Thermomètre  
rond flottant**  
0 à 40°C  
15,00 € HT



**D054M - Thermomètre  
géant flottant**  
0 à 45°C  
65,00 € HT



**D056 - Thermomètre  
flottant**  
0 à 45°C  
20,50 € HT



**D047 - Thermomètre/pH-mètre**  
Sonde intégrée  
température de 0 à 50°C  
pH de 0 à 14  
IP67  
150,00 € HT



**MOIN003 - Thermomètre infrarouge**  
-50 à 760°C  
140,00 € HT



**D070A-1 - Thermomètre  
digital type K**  
Sonde incluse  
99,00 € HT

**D070-S - Sonde filaire type K**  
100 cm  
180,00 € HT



**D072 - Thermomètre/hygromètre**  
Température -10° à 40°C  
Hygrométrie 0 à 100 %  
178,00 € HT



**D070A - Thermomètre sonde**  
-50 à 300°C IP65  
118,00 € HT



**05631080 - Thermomètre 108**  
-50 à 300°C  
IP6  
212,00 € HT



**D028 - Photomètre MD200 3 en 1**  
Mesure le chlore, le pH et l'acide cyanurique  
635,00 € HT



**D033 - Photomètre MD200 « 5 en 1 »**  
Mesure le chlore, le pH, l'acide cyanurique,  
l'alcalinité totale et la dureté calcique  
775,00 € HT



**807850 - Photomètre Pooltest 6**  
Mesure le chlore, le pH, l'acide cyanurique, la dureté calcique, l'alcalinité et le brome  
690,00 € HT



**VAT0002 - Mallette d'analyse Triklorame V2**  
1 poste d'analyse trichloramine dans l'air  
2955,00 € HT

**VAT0020 - Kit de 20 mesures de Trichloramine**  
588,00 € HT

NOUVEAU



**D053 - Photomètre portable Lilian**  
Mesure le pH et le chlore libre/total  
Analyses réalisées en 1 minute  
Inclus :  
• 1 photomètre  
• 3 gobelets doseurs  
• 1 support d'analyses  
• 1 chargeur de batteries  
• 1 pince brucelles  
• 1 kit de maintenance  
• 1 guide de démarrage  
1899,00 € HT

**D053-1 - SensoStick**  
Pour photomètre Lilian  
Lot de 300 capteurs  
750,00 € HT





**D030 - Kit standard de référence pH**  
Pour photomètre MD200  
100,50 € HT



**D029 - Kit standard de référence chlore**  
Pour photomètre MD200  
100,50 € HT



**D014 - Agitateur**  
13 cm  
3,80 € HT



**D032P - Éprouvettes**  
48 mm  
Lot de 5  
178,50 € HT



**D0325 - Éprouvettes**  
48 mm  
Lot de 5  
45,00 € HT



**D016 - DPD n°1**  
Boite de 250  
17,50 € HT



**D017-2 - DPD n°2**  
Boite de 250  
73,00 € HT



**D017 - DPD n°3**  
Boite de 250  
17,00 € HT



**D0174 DPD n°4**  
Boite de 250  
50,00 € HT



**D045 - Rouge de Phénol**  
Boite de 250  
15,00 € HT



**D019 - Acide cyanurique**  
Boite de 250  
20,00 € HT



**D064 - Glycine**  
Boite de 100  
38,00 € HT

## CARNETS SANITAIRES

Couverture rigide  
4 bassins + 1 pédiluve par page  
370 pages



**D022 - Carnet sanitaire**  
Reliure collée  
33,00 € HT



**D022S - Carnet sanitaire**  
Reliure à spirale  
34,50 € HT

## ENSEMBLES DE RÉGULATION

Fiches techniques sur demande  
Autres modèles de régulation nous consulter



**Tero**  
*Nous consulter*



**Odi Touch**  
*Nous consulter*



**Gamme Bayrol**  
*Nous consulter*

## Accessoires



**E007 - Membrane pour sonde chlore**  
150,00 € HT



**E004 - Sonde chlore**  
1900,00 € HT



**E005 - Sonde pH**  
168,00 € HT



**E008 - Gel pour membrane**  
75,00 € HT



## POMPES DOSEUSES

Fiches techniques sur demande



### Pompe doseuse Eco-Plus

<b>C014</b>	16 bars	1,1 L/h	4 x 6
<b>C015</b>	7 bars	3,9 L/h	4 x 6
<b>C016A</b>	3 bars	9,0 L/h	5 x 8
<b>C017</b>	1,5 bars	16,4 L/h	5 x 8
<b>SY018</b>	1,5 bars	21,9 L/h	5 x 8



### Beta

Pompes de dosage péristaltiques

*Nous consulter*



### Canne d'injection

<b>C018</b>	Tubing 4 x 6	115,00 € HT
<b>C019</b>	Tubing 5 x 8	115,00 € HT
<b>C032</b>	Tubing 8 x 12	75,00 € HT



### Crépine d'aspiration

<b>C023</b>	Tubing 4 x 6	100,00 € HT
<b>C024</b>	Tubing 5 x 8	120,00 € HT
<b>C036</b>	Tubing 8 x 12	120,00 € HT



### Bobine de 100 m en PE

<b>C020</b>	4 x 6	51,00 € HT
<b>C021</b>	5 x 8	78,00 € HT
<b>C059</b>	8 x 12	215,00 € HT



### Bobine de 50 m en PVDF

<b>APP001</b>	4 x 6	160,00 € HT
<b>APP002</b>	5 x 8	325,00 € HT
<b>APP003</b>	9 x 12	590,00 € HT

## DOSEURS À GALETS – MATÉRIELS DE FILTRATION



**C043B - Doseur à galets**  
Capacité 3,5 kg  
130,00 € HT



**C042 - Doseur à galets**  
Capacité 0,25 kg  
27,00 € HT



**C001 - Diatomées FW60**  
20 kg  
80,00 € HT

## PLATEAUX ET PLATEFORMES DE RETENTION



**ST1-40-B-BK - Plateau 60 L**  
155 x 800 x 600 mm  
75,00 € HT

**ST1-60-B-BK - Plateau 87 L**  
175 x 1000 x 600 mm  
80,00 € HT

**ST1-100-B-BK - Plateau 143 L**  
175 x 1200 x 800 mm  
96,00 € HT



**SJ-300-001 - Plateforme 112 L**  
1600 x 150 x 800 mm  
359,00 € HT



**C051PR60 - Plateforme 60 L**  
1000 x 600 x 175 mm  
180,00 € HT

**C051PAL40 - Plateforme 40 L**  
800 x 600 x 155 mm  
130,00 € HT

**C051PEHD - Plateforme 100 L**  
1200 x 800 x 175 mm  
200,00 € HT

## POMPES DE TRANSVASEMENT

### Pompe vide-fûts Lutz B2 Vario

Conçu pour le retrait de fluides de faible épaisseur, aqueux ou légèrement visqueux

- Régulateur de vitesse en continu avec interrupteur marche/arrêt
- Débit maximal 75 L/min
- Température d'utilisation maximale 50°C



**C067-7**  
Polypropylène  
Canne 700 mm  
990,00 € HT



**C0671-7**  
Inox  
Canne 700 mm  
1499,00 € HT

**C067-1**  
Canne 1000 mm  
1140,00 € HT

**C0671**  
Canne 1000 mm  
2200,00 € HT



## 2025 : l'année du renouveau

Depuis 2009, **LPC** met son expertise en matière d'équipements professionnels pour les piscines au service des **collectivités**, des **associations** et des **professionnels**. Au fil des années, nous avons su étoffer notre catalogue, en mettant un point d'honneur à sélectionner des équipements alliant qualité, ergonomie et durabilité. Aujourd'hui, nous proposons un large choix de produits qui saura répondre à l'ensemble de vos besoins, **du standard au sur-mesure**.

Sensible aux enjeux sociétaux, nous nous appliquons à vous proposer davantage de produits **fabriqués en France** et issus de circuits courts. Bien qu'il soit aujourd'hui impossible de vous présenter un catalogue 100 % français, nous nous attachons à vous proposer des produits majoritairement **fabriqués en Europe**. Nous élargissons également notre gamme de produits fabriqués à partir de **matières recyclées et recyclables**.

Pour 2025, vous découvrirez du **mobilier en PVC recyclé**, **trois toboggans LPC**, dont un Monogliss, des brassards en mousse LPC ergonomiques et durables, ainsi que des **systèmes d'attaches LPC** pour vos activités ludiques. Nous avons réorganisé notre service logistique pour vous garantir des délais de livraison optimaux. Notre site internet nouvellement rénové propose des fonctionnalités pratiques vous permettant d'établir vos devis incluant les frais de port et les remises le cas échéant.

## L'équipe LPC

### Devis, projets et données techniques :

**Pierre-Emmanuel BEDOUIN**

**Gérant**

06.83.29.74.98

contact@lapiscinecollective.com

**Christophe HELLEC**

**Commercial**

06.70.71.27.95

c.hellec@lapiscinecollective.com

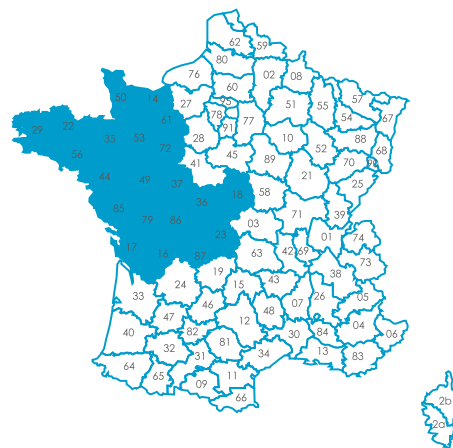
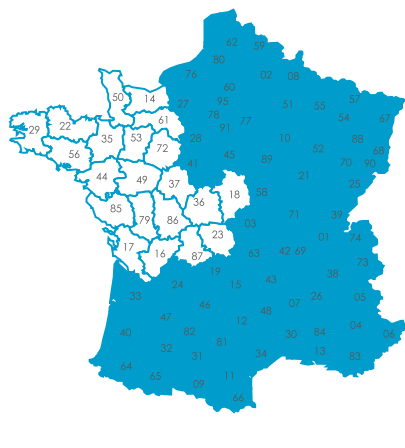

### Demande d'information et SAV :

contact@lapiscinecollective.com

### Suivi des commandes :

commande@lapiscinecollective.com

### Facturation :

compta@lapiscinecollective.com

## À Francine

*Nous ne pouvons conclure ce catalogue sans avoir une pensée particulière pour notre chère collègue Francine KIEHL, commerciale de la région Sud-Est, qui nous a quittés en fin d'année dernière. Elle aurait fêté ses 11 ans d'ancienneté chez LPC cette année.*

### 1. PRIX

Sauf conditions particulières, les prix sont établis en euros, net de toutes remises, départ entrepôt, hors transport et hors taxes. Les prix sont donnés à titre indicatif et peuvent être révisés à tout moment. Les prix applicables sont ceux en vigueur au jour de l'acceptation de la commande.

### 2. DEVIS

Les devis ont une durée de validité de 15 jours à compter de leur date d'édition. Les devis constituent un contrat dès lors qu'ils sont signés par les deux parties.

### 3. COMMANDE

Les commandes sont confirmées uniquement par écrit, sur papier ou support électronique. Le client qui transmet une commande accepte, de fait et sans réserve, les conditions de vente et renonce à toute application de ses éventuelles conditions générales d'achat.

Le minimum de commande est fixé à 100,00 € HT. Pour toute commande inférieure à ce montant, la somme de 12,00 € HT sera facturée pour couvrir les frais de traitement et de facturation.

### 4. DÉLAI

Les délais de livraison sont donnés à titre indicatif et sont sans garantie. LPC peut procéder à des livraisons partielles. Si le bien n'est pas livré à la date indiquée, l'acheteur ne peut annuler la vente ni refuser le bien, et cela ne peut donner droit à retenue, pénalité, dédommagement ou refus de paiement de la facture correspondante.

### 5. LIVRAISON

Lors de la livraison des biens :

- Ouvrir et inspecter chaque carton et palette en présence du chauffeur
- Noter chaque défaut de façon la plus précise possible (article, quantité, description de la casse) sur le bordereau de livraison
- Prendre des photos des détériorations constatées
- Sans cela, aucune démarche de notre part ne sera possible

En cas de retard, perte, avarie, vol, erreur, manquant ou défaut il appartient au client de prendre l'initiative de la réclamation auprès du transporteur, et ce, dans le délai de 3 jours.

Franco de port à partir de 3 000 € net HT.

### 6. TRANSPORT

Aucun retour de marchandises ne pourra s'effectuer avant accord de notre service commercial. Le retour doit être effectué soit en port payé, soit par enlèvement de notre transporteur à notre demande. Tous les envois en port dû seront systématiquement refusés.

### 7. PAIEMENT

Les conditions de paiement s'entendent comptant sans escompte à la réception de la facture. Règlement par mandat administratif : les conditions sont les conditions légales en vigueur à la date de la facture sans escompte.

Règlement différé : Il devra s'effectuer par traite signée, par chèque ou par virement. Des pénalités de retard au taux de l'intérêt légal de 1,5% seront systématiquement appliquées. LPC peut suspendre les commandes en cours et exiger le paiement immédiat de toutes les factures impayées.

### 8. RETOUR

Tout retour doit faire l'objet d'un accord formel et écrit entre le client et LPC. Aucun retour de marchandises ne pourra s'effectuer sans accord. Le retour doit être effectué soit en port payé, soit par enlèvement organisé par LPC. Tous envois en port dû seront systématiquement refusés.

### 9. GARANTIE

La garantie est de 2 ans à compter de la délivrance du bien, hors pièces d'usure. La garantie est renouvelée pour 2 ans à compter du remplacement du bien. La garantie est strictement limitée à la remise en état ou au remplacement du bien reconnu par LPC comme présentant un vice de fabrication, à l'exclusion de tout dédommagement à quelque titre que ce soit.

La garantie ne s'applique pas pour les cas suivants :

- Le client a connaissance des défauts au moment de la commande
- Les défauts sont liés à l'usure naturelle du bien
- Les défauts sont liés à une utilisation, un entretien ou un stockage non conforme
- Les défauts sont liés à un mauvais montage effectué par le client
- Les défauts sont liés à une modification initiée par le client

### 10. PROTECTION DES DONNÉES PERSONNELLES

Conformément à la loi informatique et libertés du 6 Janvier 1978, le client dispose des droits d'interrogation, d'accès, de modification, d'opposition et de rectification sur les données le concernant.

### 11. RÉCLAMATION

Le cas échéant, le client peut présenter toute réclamation en contactant LPC :

**LPC - La Piscine Collective**  
43 rue des Taillandiers - 72800 Le Lude  
02.43.45.19.60  
contact@lapiscinecollective.com

### 12. TRIBUNAL COMPÉTENT

Toute contestation sera réglée expressément par le Tribunal de Commerce du Mans statuant en application du Droit français.

### 13. CONCILIATION

Dans l'éventualité d'un litige et avant toute saisie du tribunal Commerce du Mans, le demandeur devra, conformément au décret 2015.282 du 11 mars 2015, et plus particulièrement des articles 18 et 19, tenter une résolution à l'amiable dudit litige par voie de conciliation.



## LPC – LA PISCINE COLLECTIVE

43 rue des Taillandiers  
72800 – Le Lude  
France

02 43 45 19 60  
contact@lapiscinecollective.com  
www.lapiscinecollective.fr