



2025



LPC – La Piscine Collective
43 rue des Taillandiers
72800 – Le Lude
France

Lundi au vendredi
08h30 – 12h00
13h30 – 17h00

02 43 45 19 60
contact@lapiscinecollective.com

NOS PARTENAIRES

 **BAYROL**
your pool & spa water expert

 **EMCO**

 **SYCLOPE**
Electronique

 **Golfinho**
SPORTS

 **Rez**

 **ecocreation**

Chers clients,

Gagnez en rapidité et en efficacité !

Pour vous garantir un service optimal, nous vous invitons à créer votre compte client directement sur notre site internet. Cet espace vous permet de :

- **Faire vos demandes de devis**
- **Suivre l'historique de vos commandes**

Créer votre compte client est simple et rapide. Rendez-vous sur www.lapiscinecollective.com et laissez-vous guider.

Vous trouverez aussi sur notre site web nos fiches techniques et nos fiches de données de sécurité. Vous pouvez également nous en faire la demande par mail si besoin.

Pour mieux vous identifier et vous assurer un suivi rigoureux, nous vous remercions de mentionner dans vos mails et lors de vos appels :

- **Votre code client**
- **Le n° de devis, commande ou facture concerné**

Ces informations sont présentes en haut à droite de nos documents de ventes. En les intégrant à nos échanges, vous nous aidez à vous apporter des réponses claires et précises.

Nous vous remercions pour votre confiance !

À bientôt,
L'équipe LPC

Rendez-vous sur notre site pour découvrir tous nos produits en scannant ce QR code :



www.lapiscinecollective.fr

LUDIQUE**Pataugeoire**

Jeux en mousse
Jeux d'eau



p. 6

Découverte

Brassards
Ballons gonflables
Tapis et radeaux

p. 9

Jeux et animations

Jeux lestés
Jeux flottants
Parcours flottants
Cages et échelles aquatiques
Toboggans
Nautilus

p. 16

ACTIVITÉS SPORTIVES**Natation**

Planches, pull-buoys et paddles
Ceintures de flottaison
Bonnets de bain
Palmes courtes et longues
Tubas

p. 28

Waterpolo

Buts et accessoires de waterpolo
Ballons de waterpolo

p. 32

Aquagym

p. 34

ÉQUIPEMENTS**Piscine**

Grilles de goulottes et accessoires
Plots de départs et accessoires
Échelles, mains-courantes et accessoires
Plongeoirs
Lignes de nage, enrouleurs et accessoires
Signalisation virage dos et faux départ
Panneaux et plaques signalétiques
Horloges et compte-secondes

p. 40

Sauna - Hamman

p. 58

Essences de hammam
Essences de sauna
Poêles électriques
Accessoires de sauna-hammam

MOBILIER**Accueil et terrasse**

p. 62

Bains de soleil

p. 64

Rangement fixe

p. 65

Rangement mobile

p. 66

Stratifié compact

p. 71

Utilitaires

p. 73

VESTIAIRES**Casiers et accessoires**

p. 76

Bancs et patères

p. 78

Serrures et accessoires

p. 81

Serrures mécaniques

Bracelets et poches de protection

Séches-cheveux

p. 83

Tables à langer

p. 83

et chaises hautes**SÉCURITÉ ET SURVEILLANCE****Matériels de surveillance**

p. 86

Chaises de surveillance

Miroirs de surveillance

Équipements de communication

Matériels de sauvetage

p. 91

Perches et bouées de sauvetage

Gilets de sauvetage

Mannequins

Matériels de premiers secours

p. 92

Appareils de diagnostic

Immobilisation et transfert

Mobilier d'infirmier

Matériels d'urgence

p. 94

Aspiration

Oxygénation

Sacs de secours

Accessibilité PMR

p. 96

Fauteuils de mise à l'eau

Fauteuils roulants spécial piscine

Fauteuils roulants spécial plage

Tabourets et sièges de douche

Barres d'appui

ENTRETIEN ET RÉGULATION**Produits chimiques**

p. 102

Produits de nettoyage

Produits de traitement de l'eau

Matériels d'entretien

p. 104

Manches télescopiques et accessoires

Centrale de nettoyage

Protection de la personne

Appareils de mesure

p. 106

Thermomètres, hygromètres

et pH-mètres

Photomètres, réactifs et accessoires

Carnets sanitaires

Appareils de dosage

p. 109

Ensembles de régulation

Pompes doseuses et accessoires

Doseurs à galets

Matériels de filtration

p. 110

Matériels de rétention

p. 111

Plateaux et plateformes de rétention

Pompes de transvasement



Antibactérien



Antifongique



Anti-UV



Étanchéité

FABRIQUÉ
EN FRANCE

Fabriqué dans l'UE





Ludique

Pataugeoire
Découverte
Jeux et animations





JEUX EN MOUSSE

Coloris assortis
Lot de 4



D179 - Canetons
28 x 23 x 3 cm
15,00 € HT



D177 - Ours
28 x 23 x 3 cm
18,00 € HT



D1000 - Dauphins
30 cm
10,00 € HT



D178 - Poissons
28 x 23 x 3 cm
15,00 € HT



M090-3 - Homard
95 x 76 x 6 cm
50,00 € HT



M090-2 - Éléphant
95 x 64 x 6 cm
50,00 € HT



M090-1 - Baleine
90 x 50 x 6 cm
40,00 € HT

Coloris selon disponibilité
L'unité

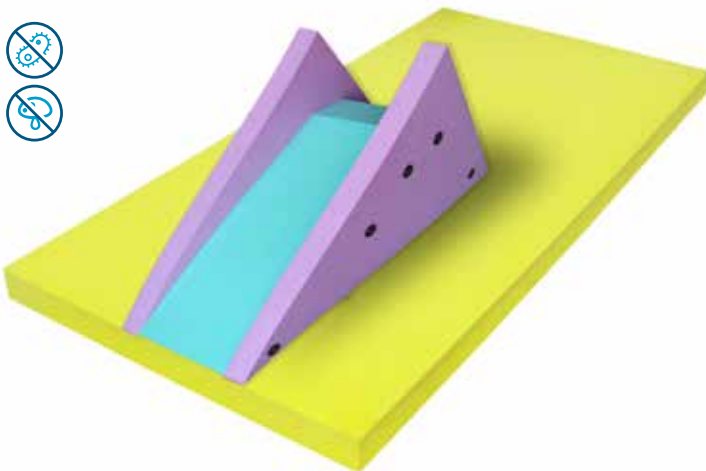

J021 - Toboggan sur tapis
200 x 100 x 90 cm
648,00 € HT

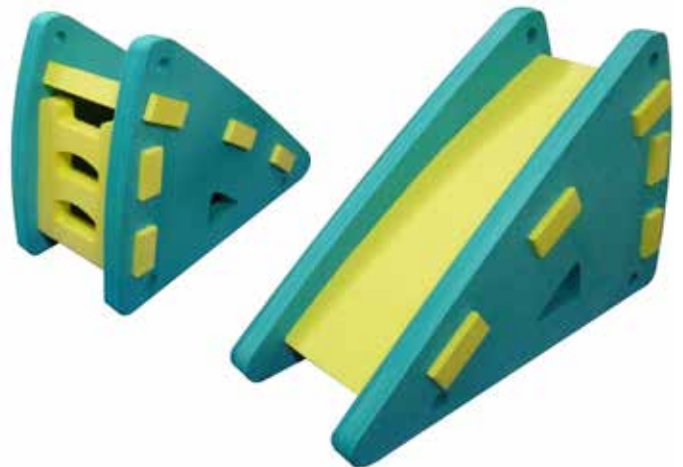

J022 - Toboggan
160 x 60 x 100 cm
400,00 € HT

Coloris selon disponibilité
L'unité

JEUX EN MOUSSE

Coloris assortis et selon disponibilité



J019 - Puzzle Alphabet

100 x 50 x 3 cm

26 pièces

24,00 € HT



J019-1 - Puzzle Géométrie

68 x 38 x 3 cm

15 pièces

12,00 € HT



J019-2 - Puzzle Alphabet

33 x 33 x 3 cm la pièce

26 pièces

130,00 € HT



J019-3 - Puzzle Chiffre

33 x 33 x 3 cm la pièce

10 pièces

50,00 € HT



J102 - Puzzle poisson

100 x 33 x 3 cm

15,00 € HT



J019-4 - Puzzle Animaux

33 x 33 x 3 cm la pièce

10 pièces

59,00 € HT



M13019 - Dés en mousse

16 x 16 cm

Lot de 2

18,00 € HT



JEUX D'EAU

Coloris selon disponibilité



J077B - Remorqueur
33 cm
L'unité
5,00 € HT



M115 - Bateaux gigognes
12 cm
Lot de 3
2,25 € HT



J077 - Bateaux
15 cm
Lot de 3
4,20 € HT



J089S1 - Seau
17 cm
2,00 € HT



M113B - Seau garni
16 cm Ø 15
5,30 € HT



Seau garni Château
M114-1 Ø 15 6,00 € HT
M114-2 Ø 20 9,00 € HT



M126A - Moulin à eau
34 cm x Ø 12 cm
4,30 € HT

L'unité



J089 - Arrosoir
17 cm
L'unité
3,10 € HT



J091 - Canards
1 gros, 3 petits 4 canards
3,80 € HT



M122 - Moules
11 cm
Lot de 8
3,30 € HT



M119A - Camion
22 cm
L'unité
4,00 € HT



J071N1-1 - Kit patageoire
40 pièces
38,00 € HT

JEUX D'EAU

En plastique souple sans phtalates
À partir de 10 mois

NOUVEAU



J085B - Aspergeurs Poissons
Lot de 4
9,00 € HT

NOUVEAU



J085C - Aspergeurs Océan
Lot de 4
9,00 € HT



J086A - Aspergeurs Nature
Lot de 4
9,00 € HT



J085A - Aspergeurs Mer
Lot de 12
18,50 € HT

BALLONS GONFLABLES

Coloris selon disponibilité



M074 - Balle
Ø 12,5 cm
L'unité
2,50 € HT



M073 - Balle
Ø 23 cm
L'unité
3,50 € HT



M073D15 - Balle
Ø 15 cm
L'unité
2,50 € HT



I048 - Pompe manuelle
3 embouts, 1 buse et 1 tuyau inclus
6,80 € HT



M069F29 - Ballon de plage
Ø 29 cm
L'unité
3,50 € HT



M073BZH - Le ballon Breton
Ø 23 cm
L'unité
2,50 € HT



L033A - Ballons visage
Ø 20 cm
Lot de 6
30,00 € HT



BRASSARDS

Paire de brassards LPC
Ergonomiques et flexibles
Mousse CO20 - Élastique sandow

NOUVEAU



LPCBR-1
Taille S ●
Trou Ø 60 mm
10,00 € HT



LPCBR-2
Taille M ●
Trou Ø 75 mm
10,00 € HT



LPCBR-3
Taille L ●
Trou Ø 87 mm
11,00 € HT



LPCBR-4
Taille XL ●
Trou Ø 100 mm
12,00 € HT



LPCBR-5
Taille XXL ●
Trou Ø 122 mm
13,00 € HT

Paire de brassards en mousse
Élastique sur demande



810090
Taille S ●
182 x 125 x 85 mm
Trou Ø 45 mm
24,00 € HT



810100
Taille M ●
182 x 125 x 85 mm
Trou Ø 50 mm
24,00 € HT



810110
Taille L ●
197 x 125 x 85 mm
Trou Ø 60 mm
24,00 € HT



810111
Taille XL ●
240 x 125 x 85 mm
Trou Ø 85 mm
24,00 € HT



J044 - Brassard Delphin
1 à 12 ans - jusqu'à 60 kg
Lot de 6 disques
32,00 € HT

Paire de brassards gonflables



J002B - Classiques
12 - 24 mois < 15 kg
6,80 € HT

J004B - Classiques
6 - 12 ans 30 à 60 kg
6,80 € HT



J003B - Classiques
2 à 6 ans 15 à 30 kg
6,80 € HT

J005B - Classiques
> 12 ans > 60 kg
6,80 € HT

J002 - Éco **J001 - Éco**
3 - 6 ans 6 - 12 ans
23 x 15 cm 30 x 15 cm
3,90 € HT 4,60 € HT

TAPIS ET RADEAUX

Coloris selon disponibilité
Mousse CO2O

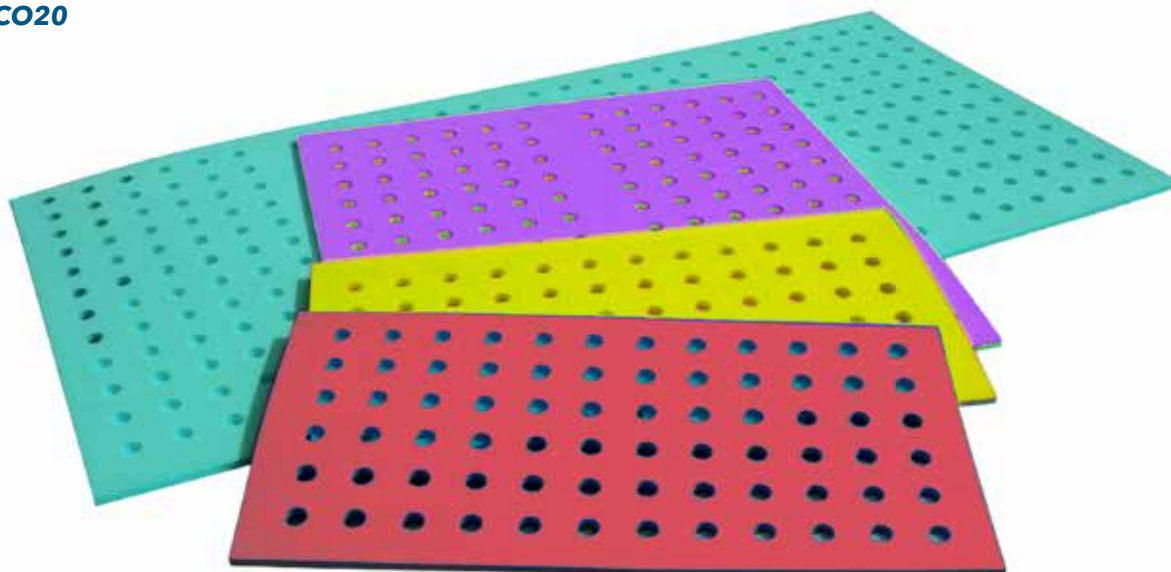

J023 - Tapis à trous 1,5 cm

100 x 50 cm	150 x 100 cm
28,00 € HT	75,00 € HT

100 x 100 cm	200 x 100 cm
48,00 € HT	80,40 € HT

J023 - Tapis à trous 3 cm

100 x 50 cm	150 x 100 cm
50,00 € HT	150,00 € HT

100 x 100 cm	200 x 100 cm
79,00 € HT	140,00 € HT

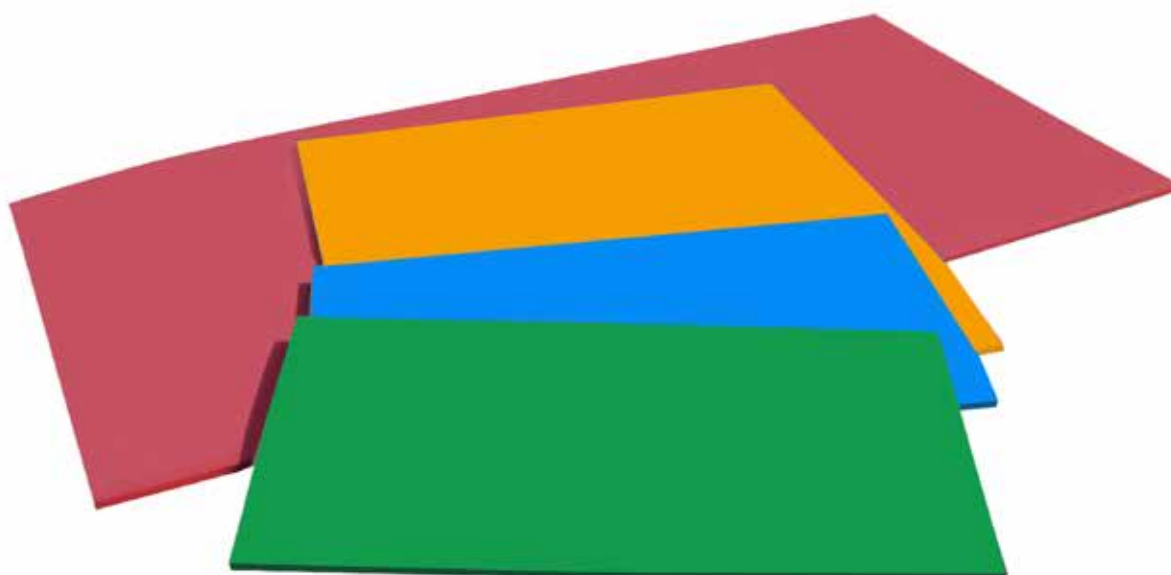

M011 - Tapis sans trous 1,5 cm

100 x 50 cm	150 x 100 cm
22,00 € HT	50,00 € HT

100 x 100 cm	200 x 100 cm
38,00 € HT	65,00 € HT

M011 - Tapis sans trous 3 cm

100 x 50 cm	150 x 100 cm
62,00 € HT	85,00 € HT

100 x 100 cm	200 x 100 cm
60,00 € HT	123,00 € HT



TAPIS ET RADEAUX

Coloris selon disponibilité
Mousse CO2O



FABRIQUÉ
EN FRANCE

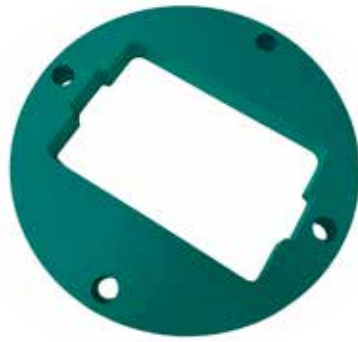

J020 - Radeau rond

Ø 100 x 9 cm

150,00 € HT

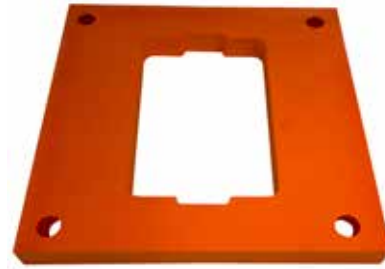

J020C1 - Radeau simple

100 x 100 x 9 cm

145,00 € HT



FABRIQUÉ
EN FRANCE



J020C - Radeau double

200 x 100 x 9 cm

320,00 € HT



J020P - Pаниère

66 x 43 x 29 cm

62,00 € HT

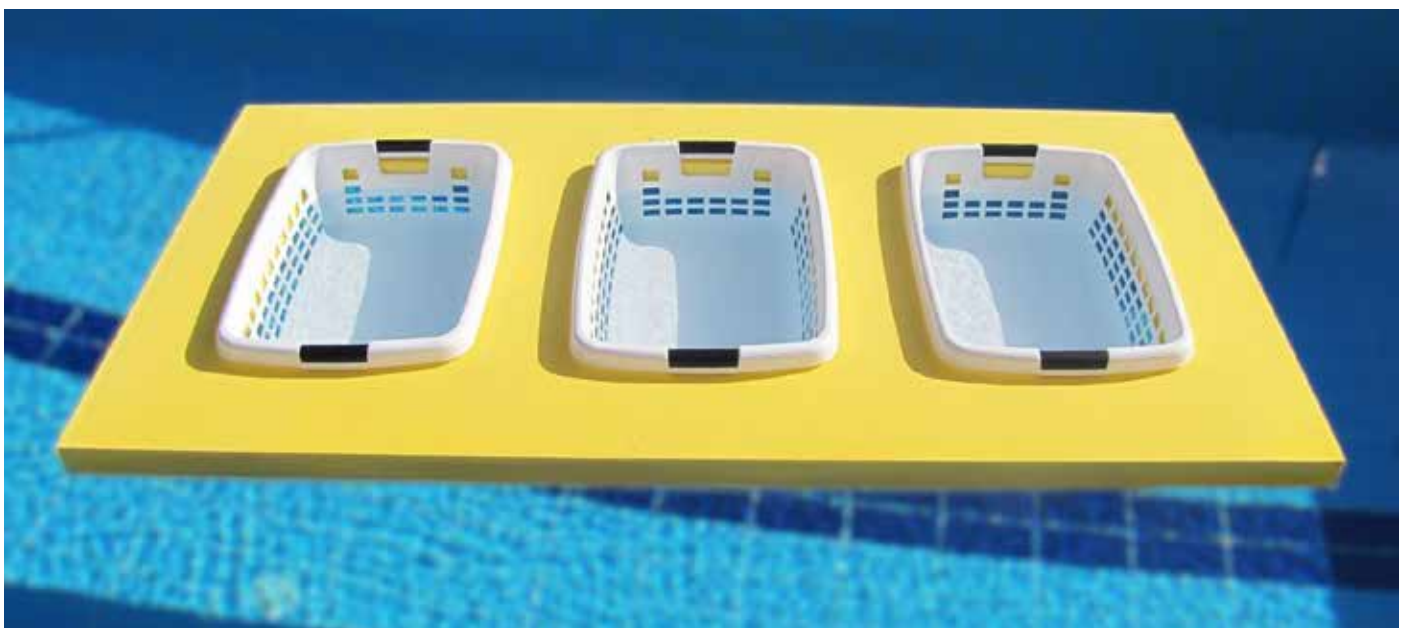

D109T - Radeau triple

200 x 100 x 6 cm

Paniers incluses

215,00 € HT

J020PG - Pаниère

64 x 46 x 23 cm

18,00 € HT

TAPIS ET RADEAUX

Coloris selon disponibilité
Mousse CO20
Épaisseur 9 cm - Trous Ø 65 mm

LUDIQUE

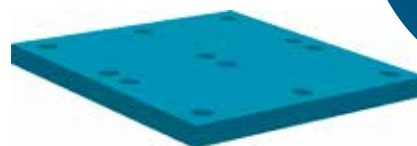
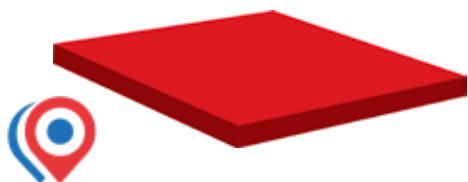

FABRIQUÉ EN FRANCE



M090M - Mini

100 x 100 cm

132,00 € HT



M090M6 - Mini 6 trous

100 x 100 cm

160,00 € HT

M090M12 - Mini 12 trous

100 x 100 cm

190,00 € HT

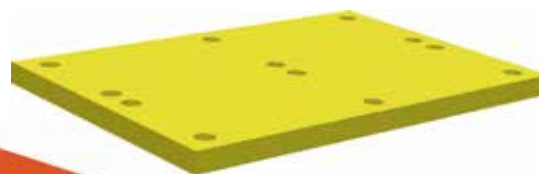

FABRIQUÉ EN FRANCE



MED001 - Medium

150 x 100 cm

212,00 € HT



MED002 - Medium 6 trous

150 x 100 cm

244,00 € HT

MED003 - Medium 12 trous

150 x 100 cm

290,00 € HT

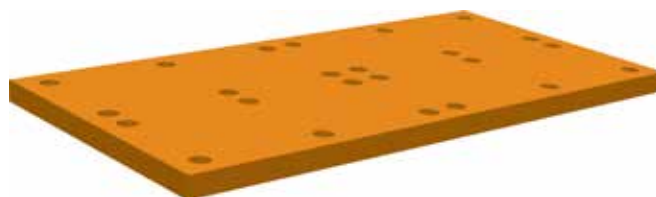
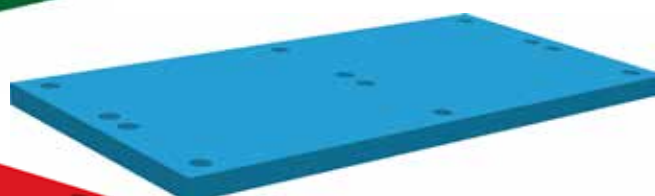

FABRIQUÉ EN FRANCE



M090 - Maxi

200 x 100 cm

316,00 € HT



M017B6 - Maxi 6 trous

200 x 100 cm

299,00 € HT

M017B12 - Maxi 12 trous

200 x 100 cm

330,00 € HT

M017B24 - Maxi 24 trous

200 x 100 cm

400,00 € HT



TAPIS ET RADEAUX



FABRIQUÉ EN FRANCE



M017AA
100 x 50 cm
85,00 € HT



M017AC
150 x 50 cm
100,00 € HT

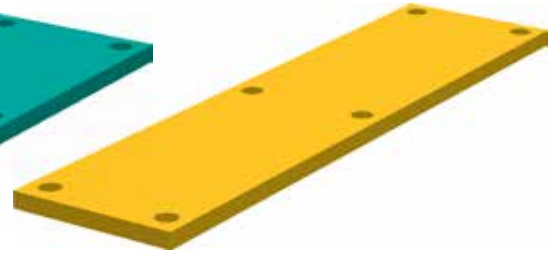

M017AB
200 x 50 cm
145,00 € HT



FABRIQUÉ EN FRANCE



PL003 - 1 trou
150 x 100 cm
Ø 60 cm + 6 trous Ø 65 mm
290,00 € HT



PL002 - 2 trous
200 x 100 cm
Ø 60 cm + 6 trous Ø 65 mm
340,00 € HT

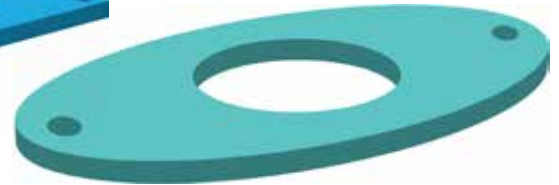

PL001-9 - Plateforme ovale
170 x 100 cm
1 trou de Ø 60 cm + 2 trous Ø 65 mm
320,00 € HT



FABRIQUÉ EN FRANCE



M090AC - Mini
100 x 100 x 6 cm
140,00 € HT



M090A - Maxi
200 x 100 x 6 cm
226,00 € HT



M026A - Maxi disque
Ø 95 x 6 cm
100,00 € HT

Barre en inox 316L



M090C - Barre murale coudée
Conçue pour 3 tapis de 9 cm
130,00 € HT

M090B - Barre murale droite
Conçue pour 6 tapis de 9 cm
95,00 € HT



FABRIQUÉ EN FRANCE



M135 - Sangle de jonction pour tapis
100 x 2,5 cm
2,75 € HT



M076 - Anneau strié
 Ø 18 cm
 L'unité
 2,50 € HT



M149 - Anneaux creux
 Ø 20 cm
 Lot de 5
 11,50 € HT



M083 - Cerceau
 Ø 72 cm
 L'unité
 10,50 € HT



M099 - Poissons
 19 x 14 cm
 Lot de 6
 5,80 € HT



M085 - 6 disques numérotés
 Ø 10 cm
 Lot de 6
 7,00 € HT



M100 - Bâtons
 21 x Ø 2 cm
 Lot de 5
 6,00 € HT



M080-2 - Balles
 Lot de 4
 12,00 € HT



M080-1 - Poulpes
 Lot de 6
 8,00 € HT



M184 - Crustacés
 Lot de 6
 34,00 € HT



GF053 - Jeu du Morpion
 Stratifié compact
 52 x 52 cm
 75,00 € HT



M083D - Demi-tunnels subaquatiques
 100 x 65 cm
 Lot de 3
 40,00 € HT

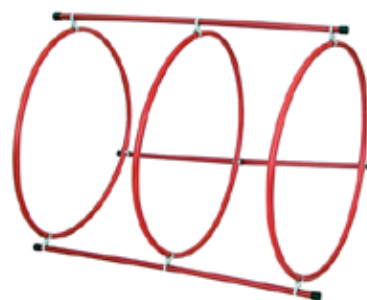

M185 - Tunnel subaquatique
 100 x 75 cm
 L'ensemble
 46,00 € HT



JEUX FLOTTANTS



M183A - Rondin
200 x Ø 27 cm
430,00 € HT



M173 - Rondin rigide
200 x Ø 25
158,00 € HT

Rondin rigide
300 x Ø 25 cm
192,00 € HT



M175 - Anneau flottant
Ø 65 mm 45,00 € HT
Ø 90 mm 55,00 € HT
Ø 120 mm 70,00 € HT

Mousse CO20
PE30 et CO30 en option



FABRIQUÉ
EN FRANCE

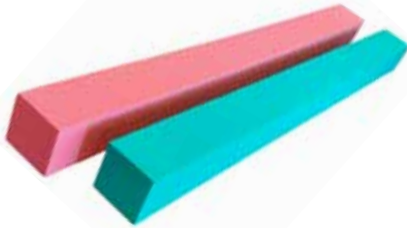

L045-9 - Frite carrée
100 x 8 x 8 cm
10,00 € HT



L045-1 - Frite
100 x Ø 6,5 cm
10,50 € HT

L045-2
100 x Ø 7,2 cm
14,50 € HT

L045
100 x Ø 8 cm
12,50 € HT

L045-3
120 x Ø 7,2 cm
16,00 € HT

L045-4
160 x Ø 7,2 cm
17,00 € HT

L045-5
200 x Ø 7,2 cm
29,00 € HT



FABRIQUÉ
EN FRANCE



L045-7 - Frite bicolore
100 x Ø 8 cm
16,00 € HT



M004P-1 - Lien plat
200 x 90 x 25 cm
Trous Ø 60 mm
Pour frite Ø 65 mm
2,80 € HT

M004P
200 x 90 x 25 cm
Trous Ø 65 mm
Pour frite Ø 72 mm
2,50 € HT

M004P-2
200 x 90 x 25 cm
Trous Ø 75 mm
Pour frite Ø 80 mm
2,90 € HT



PF2202098 - Maison LPC
200 x 100 x 100 cm
1200,00 € HT





M15D - Bouée Donut
 Ø 94 cm
 9,00 € HT



M15P - Bouée Pneu
 Ø 114 cm avec deux poignées
 8,50 € HT



M15BA - Bouée Baleine
 168 x 140 cm
 25,00 € HT



M15FC - Bouée Flamant Rose
 142 x 137 cm
 22,00 € HT



M15DR - Bouée Dragon
 201 x 191 cm
 25,00 € HT



M15L2 - Bouée Licorne
 201 x 140 cm
 22,00 € HT



MA606 - Matelas de plage gonflable
 188 x 71 cm
 21,00 € HT

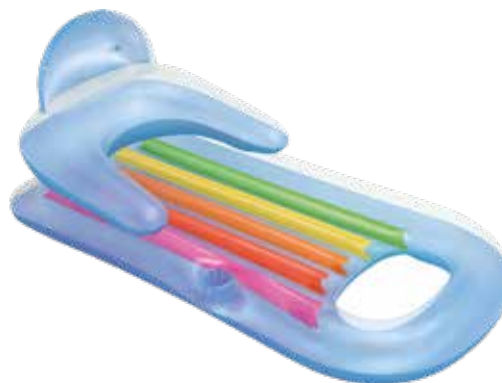

MA602 - Fauteuil matelas gonflable
 160 x 85 cm
 23,70 € HT



JEUX FLOTTANTS

Usage intérieur et extérieur

Vinyle rotomoulé

Coloris ● ● ●



AQU01 - Bouée rotomoulée

Ø 80 x 23 cm

Trou Ø 28 cm

3,8 kg

130,00 € HT

Ø 95 x 30 cm

Trou Ø 40 cm

6 kg

160,00 € HT

Ø 170 x 45 cm

Trou Ø 80 cm

16 kg

Uniquement ● ●

480,00 € HT



AQU02 - Bouée rotomoulée avec poignées

Ø 80 x 23 cm

Trou Ø 28 cm

3,8 kg

128,00 € HT

Ø 95 x 30 cm

Trou Ø 40 cm

6 kg

155,00 € HT



AQU03 - Rondin rotomoulé

95 x Ø 27 cm

3,4 kg

165,00 € HT

190 x Ø 27 cm

6,9 kg

225,00 € HT



GF056 - Panier basket

60 x 40cm

Ballon non inclus

100,00 € HT



M094 - Cerceau flottant

Ø 72 cm

2,70 € HT



M153 - Panneau de basket

Panneau stratifié compact

(PVC en option)

Tube et arceau inox

Ø 43 mm

560,00 € HT

NOUVEAU

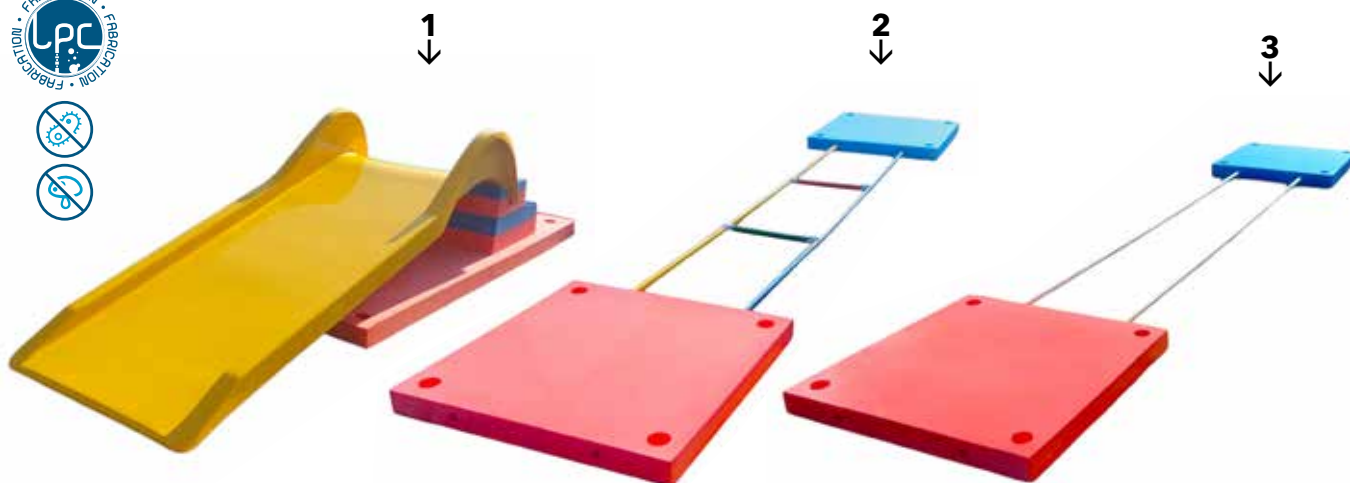

1 + 2 + 3

LPC-PA3 - Grand parcours aquatique LPC

Toboggan + échelle + pont de singe

Jonctions incluses

12,5 m

2500,00 € HT

2 + 3

LPC-PA2 - Parcours aquatique moyen LPC

Échelle + pont de singe

10 m

1015,00 € HT

1

LPC-PA5 - Petit parcours toboggan Monogliss

Accès marche et tapis inclus

2,5 m

1200,00 € HT

2

LPC-PA1 - Petit parcours pont de singe

5 m

500,00 € HT

3

LPA-PA1-1 - Petit parcours échelle

5 m

555,00 € HT

NOUVEAU



H041G-1 - Pont de singe spécial apprentissage

2 lignes sans flotteurs

Supports en T en option

À partir de 5 m

10,00 € HT le mètre linéaire





PARCOURS FLOTTANTS

LE PARC DES BAMBINS

6 mois à 2 ans



FABRIQUÉ
EN FRANCE

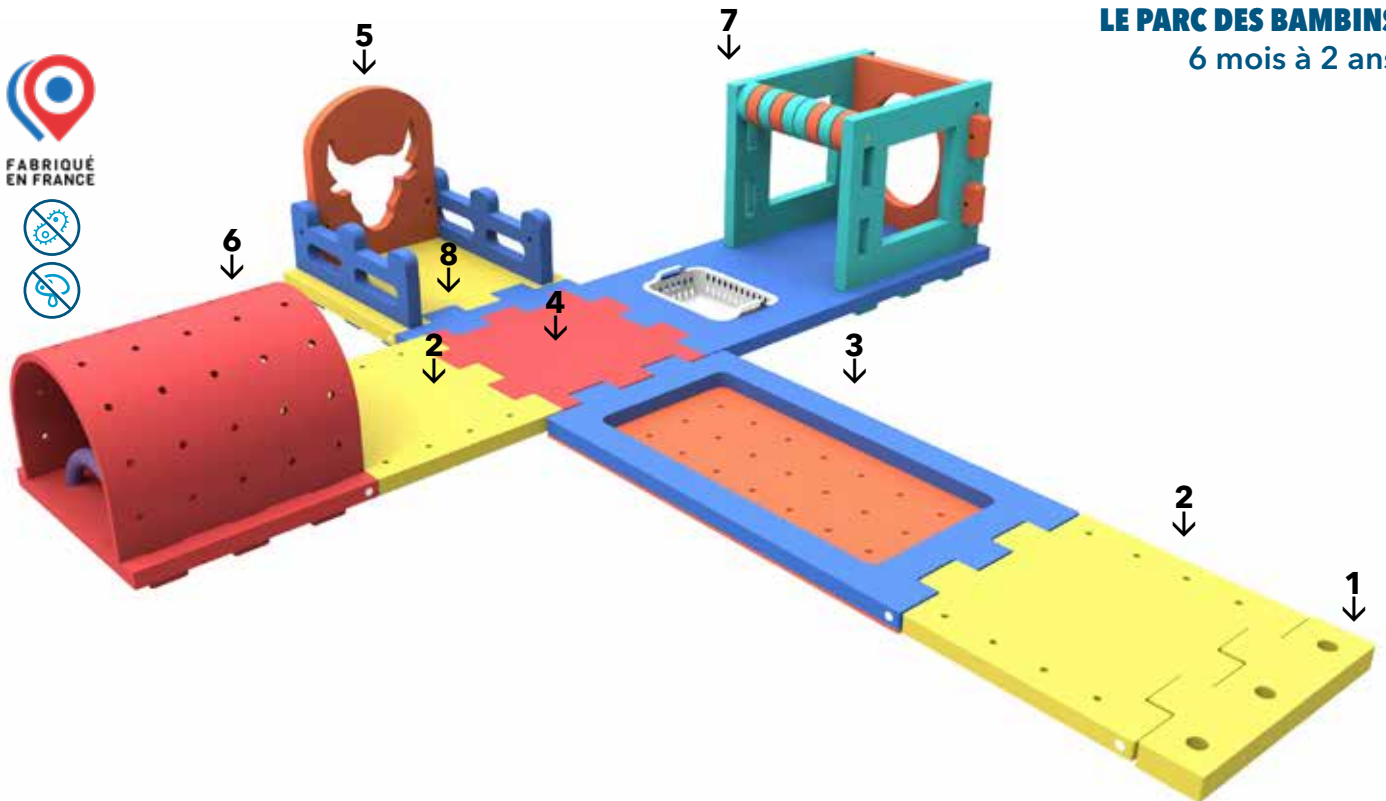

1
MA001-23B - Raccord mixte mâle
100 x 30 x 9 cm
85,00 € HT

2
MA001-7B - Petit tapis simple
100 x 100 x 7 cm
217,00 € HT

3
MA001-18B - Pataugeoire maxi
200 x 100 x 9 cm
532,00 € HT

4
MA001-13B - Tapis toutes directions
100 x 100 x 7 cm
267,00 € HT

5
MA001-56 - Bébé Ranch
100 x 100 x 100 cm
550,00 € HT

6
MA001-55 - Hutte de bébé
100 x 100 x 100 cm
370,00 € HT

7
MA001-46 - Maison bébé Robinson
200 x 100 x 100 cm
1038,00 € HT

8
MA001-26B - Raccord mâle-mâle
100 x 30 x 9 cm
85,00 € HT

Parcours individuels



FABRIQUÉ
EN FRANCE

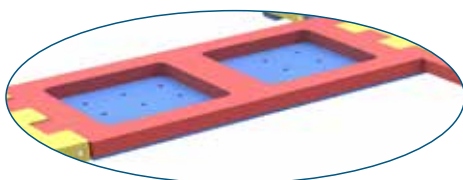

MA001-17B - Pataugeoire double
200 x 100 x 9 cm
6 mois à 2 ans
532,00 € HT



MA001-53 - Saut d'obstacles I
200 x 100 x 17cm
2 ans à 6 ans
585,00 € HT

LE PETIT BAROUDEUR

3 ans à 6 ans



FABRIQUÉ EN FRANCE

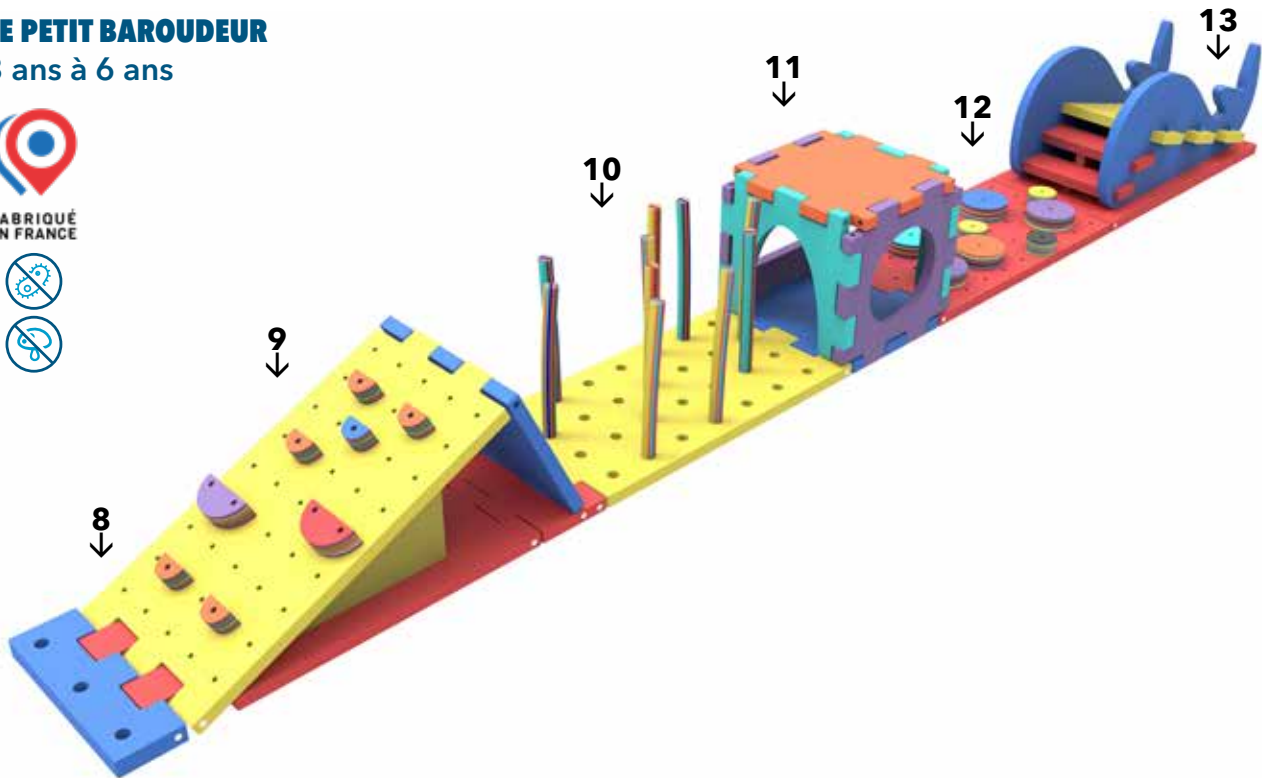

8
MA001-24B - Raccord mixte femelle
 100 x 30 x 9 cm
 85,00 € HT

9
MA001-47 - Mur d'escalade flottant
 250 x 100 x 80 cm
 4 à 6 ans
 1318,00 € HT

10
MA001-48 - Maxi labyrinthe
 200 x 100 x 7 cm
 6 mois à 6 ans
 620,00 € HT

11
MA001-49 - Maison Ludi'O avec toit
 100 x 100 x 100 cm
 1340,00 € HT

12
MA001-50 - Tapis à pois
 200 x 100 x 17 cm
 6 mois à 6 ans
 650,00 € HT

13
MA001-51 - Toboggan Balein'O
 200 x 100 x 100 cm
 6 mois à 6 ans
 1736,00 € HT

Parcours individuels



FABRIQUÉ EN FRANCE

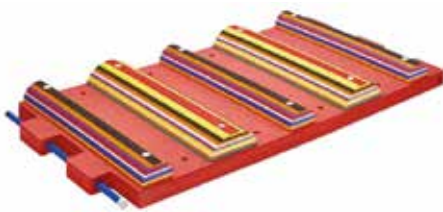

MA001-52 - Tapis combiné
 200 x 100 x 17 cm
 2 ans à 6 ans
 770,00 € HT

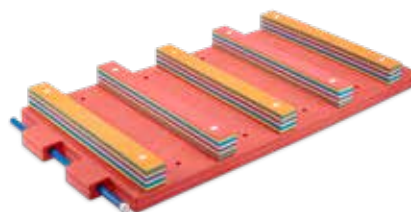

MA001-6B - Grand tapis simple
 200 x 100 x 7 cm
 416,00 € HT



PARCOURS FLOTTANTS

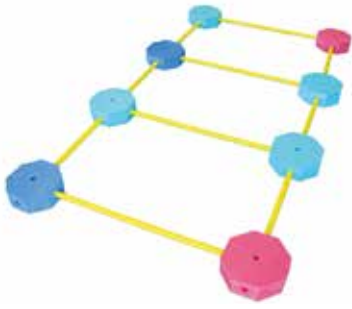

GF0108 - Parcours 8 flotteurs

+ 4 barres de 1 m
+ 6 barres de 60 cm
88,00 € HT



GF01020 - Parcours 20 flotteurs

+ 16 barres de 1 m
+ 15 barres de 60 cm
215,00 € HT

L075AHEX - Flotteur octogonal

Ø 26 x 8,5 cm
14,50 € HT



FABRIQUÉ
EN FRANCE



Charge admissible 35 kg
Renforcé pour adultes en option

M017 - Ponceau flottant

Mousse PE GA40
Largeur 120 cm
À partir de 5 m
55,00 € HT le mètre



M040T - Tapis flottant vertical

PVC
200 x 160 cm
1 trou de Ø 75 cm
2 œillets de fixation
164,00 € HT



FABRIQUÉ
EN FRANCE



M040 - Tapis flottant vertical

PVC
200 x 160 cm
2 trou de Ø 75 et Ø 60 cm
2 œillets de fixation
175,00 € HT

CAGES ET ÉCHELLES AQUATIQUES

Passages colorés non inclus



M053 - Cage 24
150 x 150 cm
621,00 € HT



M054 - Cage 27
200 x 200 cm
890,00 € HT

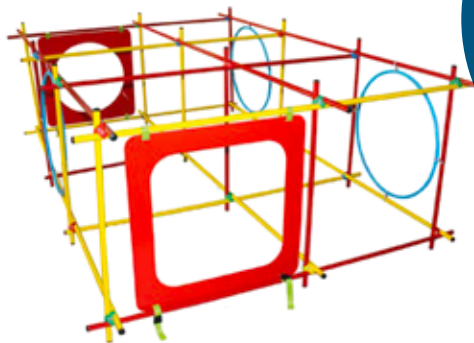

J267 - Cage 30
300 x 200 x 100 cm
604,00 € HT



J2642 - Passage rond
65,00 € HT



J2544 - Passage triangle
65,00 € HT



J2545 - Passage hexagonal
65,00 € HT



J265 - Passage cercle
15,00 € HT

Échelles aquatiques Barres Ø 30

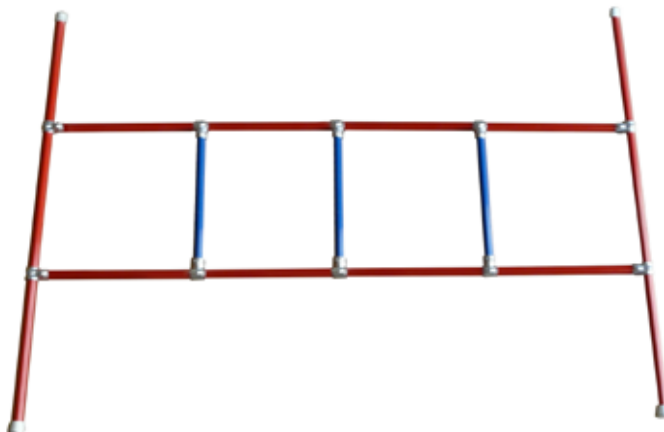

M053E - 1,50 m
165,00 € HT

M053EP - 2 m
196,00 € HT

M053EP3 - 3 m
255,00 € HT



M056 - Jonction boule
Ø 25
7,00 € HT



M05632
Ø 30
10,00 € HT



M0572T30 - Jonction en T
Ø 30
10,50 € HT

M0573T30 - Jonction 3 sorties
Ø 30
14,00 € HT



Embout couvrant
M058
Ø 30
2,50 € HT



M103 - Embout entrant
Ø 30
1,25 € HT



TOBOGGANS

NOUVEAU



LPC-T1 - Toboggan LPC sur roues

Monté sur 4 roues
Hauteur 196 cm
Hauteur assise 125 cm
Longueur 259 cm
3000,00 € HT

NOUVEAU



LPC-T2 - Toboggan LPC classique

Longueur 270 cm
Largeur 125 ou 150 cm
À partir de 2000,00 € HT



M070M - Toboggan rigide

Glissière 200 cm
Assise 50 x 40 cm
690,00 € HT

M070GM - Toboggan rigide

Glissière 205 cm
Assise 62 x 40 cm
730,00 € HT

TOBOGGANS

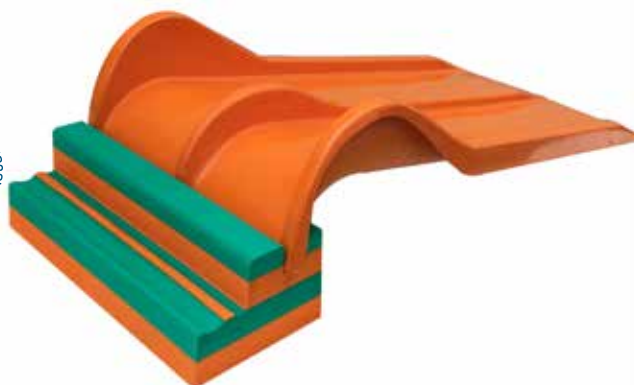

M158 - Toboggan Bigliss

Marches non incluses
Jusqu'à 10 ans
240 x 108 cm
Au sol 250 cm
660,00 € HT



M158-1 - Toboggan Monogliss

Marches et tapis non inclus
Jusqu'à 10 ans
240 x 108 cm
Au sol 250 cm
660,00 € HT

M158A-1 - Marches d'accès

Mousse PE
110 x 48 x 33 cm
270,00 € HT

NAUTILUS

Base Ø 120 cm
Hauteur 80 cm
Trou supérieur Ø 50 cm



NAUTI - Nautilus Original
600,00 € HT



Nautilus Bulle
Bulle plexiglas
650,00 € HT



Nautilus Plaque
Plaque plexiglas
630,00 € HT





Activités Sportives

Natation
Waterpolo
Aquagym

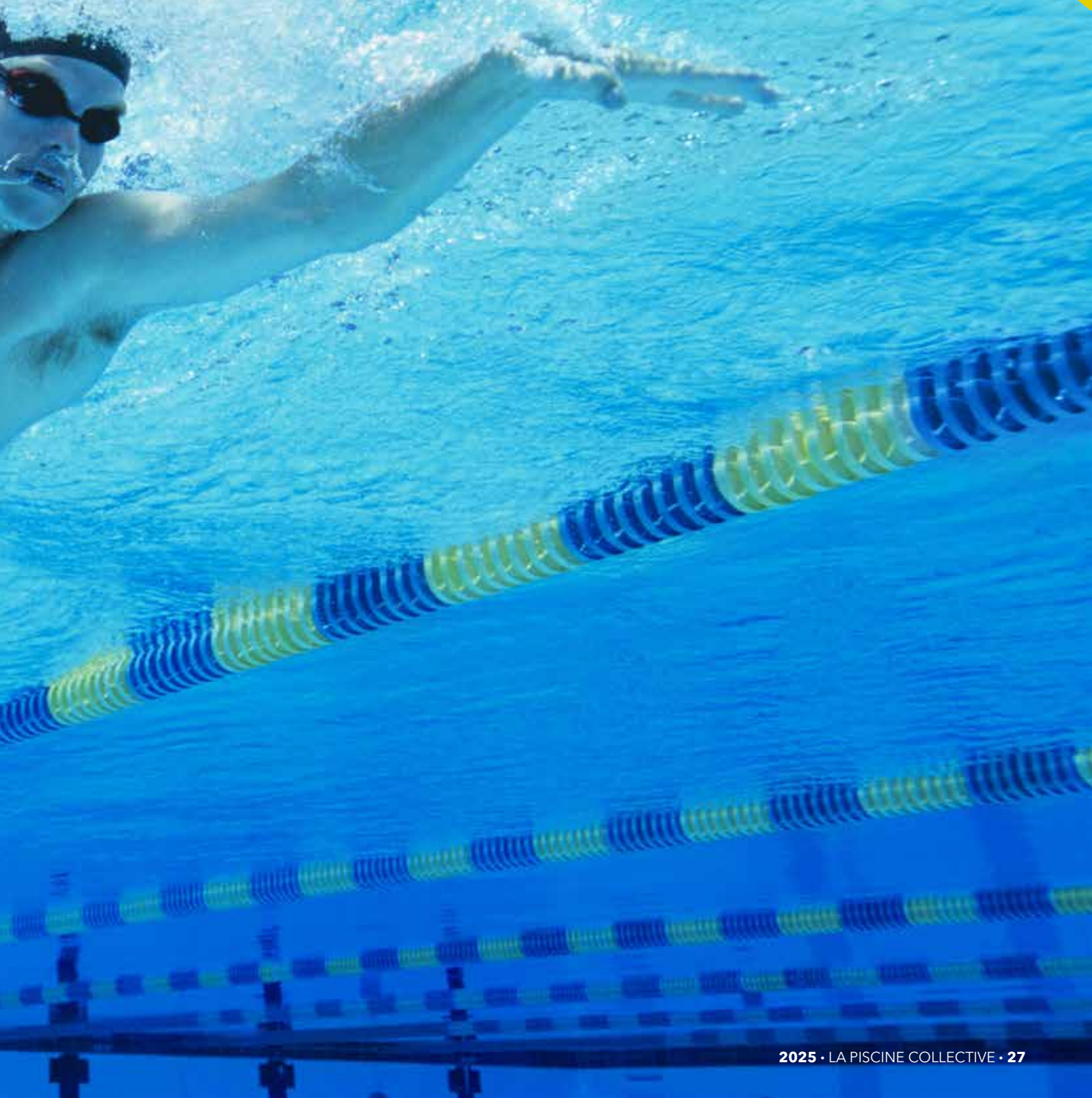



PLANCHES, PULL-BUOYS ET PADDLES

Mousse PE



GF022 - Planche petit format
29 x 22 x 3 cm
10,00 € HT



J029 - Planche standard
48 x 27,5 x 3,5 cm
10,80 € HT



J031 - Planche à poignées
45 x 30,5 x 3 cm
16,00 € HT



PL009G - Planche à trous
39 x 32 x 3 cm,
2 trous Ø 4 cm
20,00 € HT

*Chape avec une partie plus développée
Mousse PE*



J047 - Pull-buoys standard
23 x 14,5 x 7/8 cm
7,50 € HT



J046 - Pull-buoy junior
23 x 11 x 5/6 cm
6,00 € HT

PLANCHES, PULL-BUOYS ET PADDLES



GFO52 - Paddles
Taille L
5,50 € HT



GFO51 - Paddles
Taille M
5,00 € HT



GFO50 - Paddles
Taille S
4,50 € HT

CEINTURES DE FLOTTAISON



J036A5 - Ceinture 5 flotteurs
Sangle pvc
Boucle inox
15,00 € HT



J036 - Ceinture 4 flotteurs
Sangle pvc
Boucle inox
14,00 € HT



J042 - Flotteur de recharge

Se décline en plusieurs matières et tailles



PE30
180 x 70 x 35 mm
1,50 € HT

CO20
180 x 70 x 35 mm
1,75 € HT

CO30
180 x 70 x 45 mm
1,75 € HT

PE30
180 x 70 x 45 mm
1,75 € HT

CO20
180 x 70 x 45 mm
2,00 € HT

PE30
180 x 70 x 65 mm
2,00 € HT

CO20
180 x 70 x 65 mm
2,25 € HT



Sangle PVC
Boucle inox
Coloris ● ● ● ○



Sangles

J038 1,20 m 8,00 € HT	J038P 1,00 m 6,50 € HT	J038P8 0,80 m 6,50 € HT
------------------------------------	-------------------------------------	--------------------------------------



Bonnets personnalisés

Marquage :	2 côtés - 1 couleur	Latex ou silicone
1 côté - 2 couleurs	2 côtés - 2 couleurs	Couleurs
1 côté - 3 couleurs	2 côtés - 3 couleurs	● ● ● ● ● ● ● ●



J028U - Polyamide uni

● ● ● ● ● ●
1,00 € HT



J028B - Polyamide bicolore

● ● ● ● ● ●
● ● ● ● ● ●
● ● ● ● ● ●
1,00 € HT



J027B - Latex

● ● ● ● ● ● ● ● ● ●
0,90 € HT

J097 - Silicone

● ● ● ● ● ● ● ● ● ●
2,50 € HT

PALMES COURTES ET LONGUES

100 % caoutchouc
1 couleur par taille



MAD01 - Palmes courtes

26/29 ● 13,00 € HT	36/37 ● 13,00 € HT	42/43 ● 16,00 € HT
30/33 ● 13,00 € HT	38/39 ● 16,00 € HT	44/45 ● 19,00 € HT
34/35 ● 13,00 € HT	40/41 ● 16,00 € HT	46/48 ● 19,00 € HT



L013 - Palmes courtes Cressi Light

Pour l'aquagym et l'entraînement

31/32 - 33/34 - 35/36 - 37/38 - 39/40 - 41/44 - 43/44 - 45/46



29,00 € HT

L013BL



29,00 € HT

100 % caoutchouc
1 couleur par taille



MAD02 - Palmes longues

26/29 ● 18,00 € HT	34/35 ● 18,00 € HT	38/39 ● 18,00 € HT	42/43 ● 21,00 € HT	46/48 ● 24,00 € HT
30/33 ● 18,00 € HT	36/37 ● 18,00 € HT	40/41 ● 18,00 € HT	44/45 ● 21,00 € HT	



K007 - Palmes longues Lagon

Fentes hydrodynamiques

Languette et soufflet permettant un (dé)chaussage facile

Anneau pour le rangement et le transport

Pour le loisir et l'entraînement

30/32 - 33/34 - 35/36 - 37/38 ● ○ ● ●

39/40 - 41/42 - 43/44 - 45/46 ● ○ ● ●

18,00 € HT



TUBAS



K077 - Tuba frontal Air senior
À partir de 12 ans
21,00 € HT

K078 - Tuba frontal Air junior
6 à 12 ans
21,00 € HT



K077F1 - Tuba frontal Finis senior
À partir de 12 ans
40,00 € HT

K077FJ - Tuba frontal Finis junior
8 à 12 ans
30,00 € HT

BUTS ET ACCESSOIRES DE WATERPOLO



I028COMP - Buts officiels de compétition

Homologués FINA et LEN 300 x 90 cm
Filets non inclus
La paire
4940,00 € HT

I029 - Filets de buts de compétition

Maille PP haute résistance Ø 4 mm
300 x 100 x 80 cm
La paire
175,00 € HT



M061 - Buts d'initiation

PVC, nylon et mousse PE
150 x 70 x h 80 cm
PVC flottant
Filets inclus
La paire
449,00 € HT

I029B - Filets spécifiques
Nous consulter



I032 - But gonflable

300 x 90 cm
L'unité
599,00 € HT

BALLONS DE WATERPOLO



I046-13 - Ballon K7 LEN

Taille 5
48,00 € HT



I046-12 - Ballon K7 LEN

Taille 4
48,00 € HT



I046-7 - Ballon K7

Taille 4 Officiel Junior
42,00 € HT



I046-6 - Ballon K7 Multicolore

Taille 3 scolaire
30,00 € HT



**I046-11 - Ballon K7 LEN
Ligue des champions homme**

Taille 5
50,00 € HT



**I046-10 - Ballon K7 LEN
Ligue des champions femme**

Taille 4
50,00 € HT



**I046-8 - Ballon K7 LEN Multicolore
Femme**

Taille 4
50,00 € HT



I046-5 - Ballon K7

Taille 3
28,00 € HT



MATÉRIEL D'AQUAGYM

Inox 316L

Fiches techniques sur demande



DYB003 - Vélo aquatique Variant

140 x 60 cm
21 kg
2300,00 € HT



DYBD01 - Vélo aquatique Basic

140 x 60 cm
19 kg
1850,00 € HT

NOUVEAU



WX-ELLY - Vélo elliptique

Profondeur d'eau 110 à 150 cm
Aluminium
118 x 56 x 179 cm
23 kg
1400,00 € HT



CIMA001 - Step LPC

67 x 35 x 17 cm
7 kg
85,00 € HT

CIMA001V - Ventouse

Pour step CIMA001
1,65 € HT



L041CH - Chariot à step

140 x 79 x 115 cm
Capacité 9 steps
4 roues dont 2 avec frein
521,50€

HALTÈRES

La paire
Mousse PE



GF027-1 Haltères hexagonaux
25 x 20 x 6 cm
20,00 € HT



L070 - Haltères plats
28 x 15 x 3 cm
3,80 € HT



MAD005 - Haltères rigides
EVA
35 x 17 x 12 cm
30,00 € HT

La paire
Vinyle



L062 - Haltères lestés
2 x 1 kg
6,00 € HT

2 x 2 kg
7,50 € HT

2 x 3 kg
11,00 € HT

La paire
Mousse PE et PVC



L021A - Haltères ronds
Mousse PE et PVC
30 x Ø 15 x 6 cm
13,50 € HT



L021F - Haltères carrés
30 x 9 cm
11,00 € HT



H973M - Haltères croix
30 x 16 x 4,5 cm
11,00 € HT

PVC



Balle lestée
L034
1 kg
Ø 12 cm
6,60 € HT

L035
2 kg
Ø 15 cm
8,50 € HT



Bracelets lestés

L067

2 x 0,5 kg

16,50 € HT

L0671

2 x 1 kg

22,50 € HT

Pour poignets et chevilles
La paire



L104 - Bracelets en mousse

60 x 11,5 x 2 cm

11,00 € HT



J052 - Chevilles - Donut

Ø ext. 240 mm

Ø int. 90 mm

8,00 € HT



J053 - Poignets - Donut

Ø ext. 120 mm

Ø int. 50 mm

5,50 € HT



GFD188 - Barre haltères ronds

107 x Ø 15 cm

Floteurs Ø 36 cm

L'unité

19,00 € HT

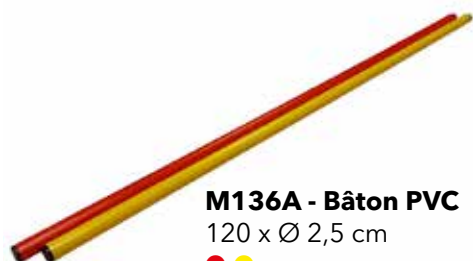

M136A - Bâton PVC

120 x Ø 2,5 cm



L'unité

5,00 € HT



Élastiband

L046-1

Force 10 kg



8,00 € HT



L046-2

Force 15 kg



8,00 € HT



L046-3

Force 20 kg



9,00 € HT

L'unité



L075A - Floteur rond

25 x 25 x 8,5 cm

14,50 € HT



L033 - Overball

Ø 26 cm

7,50 € HT

La paire



L030AG - Gants d'aquacombat

Mousse EVA

27 x 17 x 3 cm

10,00 € HT



L027F - Gants d'aquagym

Néoprène

Taille S ● Taille M ● Taille L ●

15,00 € HT

Mousse PE



L113 - Jambières

Taille L - 30 cm

La paire

22,00 € HT



Taille S - 20 cm

La paire

15,00 € HT



L038 - Ceinture Aqua

74 x 22,5 x 4 cm

L'unité

16,00 € HT

SONORISATION



IPX4

17-2505 - Sono Ibiza 300W

Éclairage à LED
Puissance de sortie totale 300W
Possibilité de chaîner jusqu'à 3 enceintes
Entrées AUX, USB, FM, Micro et Guitare
Bluetooth et NFC
Écho réglable pour guitare et micro
Tuner FM avec 4 touches de mémoire

1 power bank USB 5V 1A
Batterie 12V 4.5A intégrée
Jusqu'à 7 h d'autonomie
Roues et trolley télescopique
Étanchéité IPX4
51 x 30 x 45 cm
13,6 kg
Inclus :
• 1 micro sans fil
• 1 chargeur
• 1 pochette
390,00 € HT



IP54

BST001 - Sono 400W

Puissance de sortie totale 400W
Entrées USB et Micro
Bluetooth et MP3
Double récepteur UHF
Batterie 25.2V 8A
Jusqu'à 6 h d'autonomie
Roues et trolley télescopique
Étanchéité IP54

47,4 x 44,2 x 63,8 cm
16 kg
Inclus :
• 2 micros sans fil
• 1 pochette
• 1 télécommande
• 1 chargeur
990,00 € HT



IPX4

IBI001-1 - Sono Ibiza 700W

Puissance de sortie totale 700W
Possibilité de chaîner jusqu'à 3 enceintes
Correcteurs de graves et d'aigus
Contrôle de volume séparé des microphones, écho et haut-parleur
Entrées AUX, USB, FM, Micro et Guitare
Lecteur MP3, WMA et WAV via USB et Bluetooth
Fonction VOX
Batterie 4500mA intégrée

Jusqu'à 7 h d'autonomie
Roues et trolley télescopique
36 x 34,5 x 56 cm
10,9 kg
Inclus :
• 1 micro sans fil
• 1 micro-tête
• 1 télécommande
• 1 chargeur
• 1 pochette
• 1 haut-parleur subaquatique 30W
990,00 € HT



GF054 - Tapis d'animateur

Antidérapant et absorbe les chocs
100 x 100 x 3 cm
45,00 € HT







Équipements

Piscine
Sauna – Hammam





GRILLES DE GOULOTTES ET ACCESSOIRES

Prise de côtes et pose en option
PP traité anti-UV
Le mètre linéaire

Coloris



Grilles perpendiculaires enroulables

- Liaison câble pur souple avec entretoises
- Largeur 100 à 500 mm
- Profilés pleins 22 x 10 mm
- Écartement des profilés 8 mm
- Antidérapant

G001
22 mm
132,00 € HT

G002
25 mm
164,00 € HT

G003
27 mm
181,00 € HT

G004
35 mm
205,00 € HT



Prise de côtes et pose en option
PP traité anti-UV
Le mètre linéaire

Coloris

Grille parallèle rigide

- Liaison par tubes porteurs en polyester armés de fibre de verre
- Largeur 100 à 300 mm
- Profilés arrondis largeur 10 mm
- Écartement des profilés 8 mm
- Antidérapant

G036
22 mm
164,00 € HT

G038
27 mm
215,00 € HT

G037
25 mm
210,00 € HT

G039
35 mm
243,00 € HT

Nous consulter

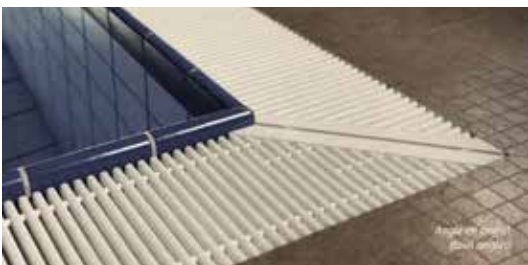

G042 - Angle en onglet
75 à 120°

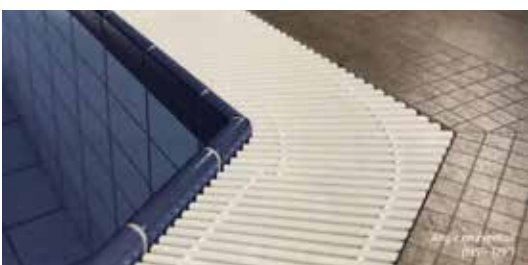

G042E - Angle en éventail
120 à 179°

GRILLES DE GOULOTTES ET ACCESSOIRES



Prise de côtes et pose en option
PP traité anti-UV
L'unité



Grille perpendiculaire en plaque

G025 200 x 245 x 22 mm 9,00 € HT	G026 200 x 295 x 22 mm 11,00 € HT	G027 200 x 335 x 22 mm 11,00 € HT
---	--	--

Prise de côtes et pose en option
PP traité anti-UV
L'unité
Coloris ● ● ● ● ● ●

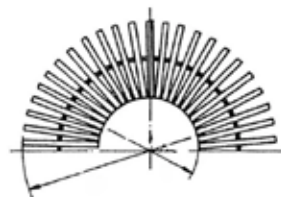
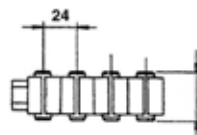

Grille perpendiculaire spécial arrondi

G017 100 x 195 x 22 mm 1,20 € HT	G020 100 x 335 x 22 mm 1,80 € HT	G018 100 x 245 x 22 mm 1,60 € HT	G019 100 x 295 x 22 mm 1,70 € HT
G023 100 x 295 x 35 mm 2,00 € HT	G021 100 x 195 x 35 mm 1,45 € HT	G024 100 x 335 x 35 mm 2,20 € HT	G022 100 x 245 x 35 mm 2,00 € HT

Perpendiculaires - Caillebotis d'angle à 90°
L'unité



G017A L195 mm H22 mm 60,00 € HT	G018A L245 mm H22 mm 85,00 € HT	G019A L295 mm H22 mm 100,80 € HT
G020A L335 mm H22 mm 126,00 € HT	G021A L195 mm H35 mm 66,00 € HT	G022A L245 mm H35 mm 82,00 € HT
G023A L295 mm H35 mm 103,00 € HT	G024A L335 mm H35 mm 131,00 € HT	

Prise de côtes et pose en option
PP traité anti-UV
5 plaques = 1,024 mètre linéaire



Grille parallèle en plaque

G072-195 195 x 24 mm 15,00 € HT	G072-245 245 x 24 mm 12,50 € HT	G072-295 295 x 24 mm 16,50 € HT	G072-345 345 x 24 mm 16,00 € HT
--	--	--	--



GRILLES DE GOULOTTES

Prise de côtes et pose en option

Tarifs au mètre linéaire

Coloris ○ ● ● ● ● ● ●



GR2/22/245 - Grille perpendiculaire enroulable

Largeur entre 100 et 900 mm

Hauteur 22, 25, 30 et 35 mm

À partir de 108,00 € HT



Grille perpendiculaire courbable

GR47/20/295

Largeur 295 mm

Hauteur 20 mm

À partir de 100,00 € HT

GR47/25/250

Largeur 180, 200, 205, 250 et 300 mm

Hauteur 25 mm

À partir de 90,00 € HT



GR20 - Grille parallèle

Largeur 150 à 400 mm

Hauteur 25 mm

À partir de 98,00 € HT



GLE5013-1 - Tapis antidérapant

60 cm x 10 m

34 kg

425,00 € HT

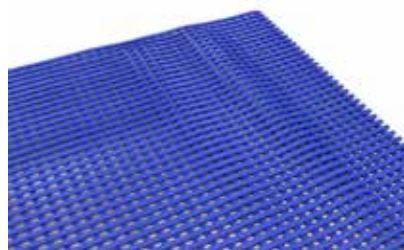

GLE5013-2 - Tapis antidérapant

120 cm x 10 m

69 kg

850,00 € HT

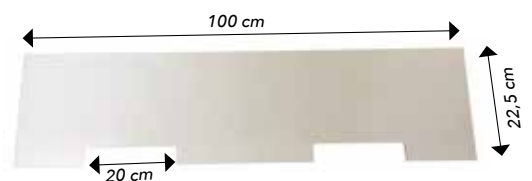

SOTRAP001 - Plaque antibruit

PVC

100 x 22,5 cm

50,50 € HT

PLOTS DE DÉPART ET ACCESSOIRES



Normes FINA

Capteur faux départ et logo en option

Numéro inclus

Barre de départ inox 316



H007 - Plot de départ start droit

Base Inox AISI 316
500 x 500 x 400 mm

●
645,00 € HT

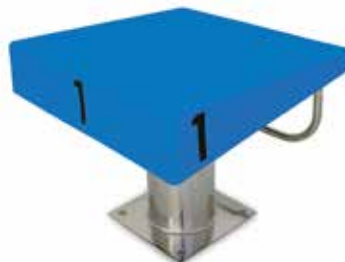

H004 - Plot de départ base ronde

Base inox 316
500 x 500 x 400 mm

●
515,00 € HT



H007B - Plot de départ start droit

Réglable sur 3 positions
500 x 500 x 400 mm

○ ●
670,00 € HT



H007D - Plot de départ start droit

Barre de départ en U spécial dos crawlé
Base inox 316

●
670,00 € HT

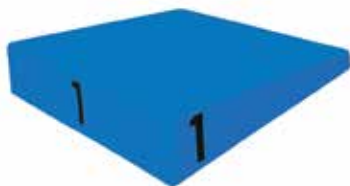

H011 - Plateforme inclinée

Pour réf. H007 et H004
Fibre de verre
500 x 500 mm

●
214,00 € HT



H010 - Plateforme renforcée

Pour réf. H007B
Fibre de verre
500 x 500 mm

○ ●
320,00 € HT



H012 - Numéro

De 0 à 9
A l'unité
3,70 € HT

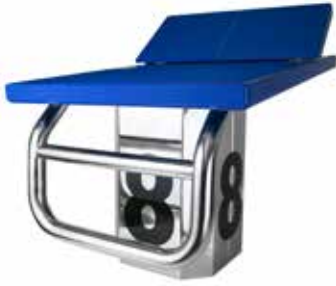

H001Z - Plot de départ octogonal

Base inox
240 x 240 mm
1320,00 € HT

H001Z1 - Avec track start

1700,00 € HT

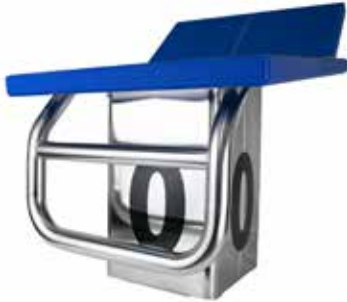

H002Z - Plot de départ rectangulaire

Base inox
240 x 240 mm
1280,00 € HT

H002Z1 - Avec track start

1650,00 € HT



H003Z1 - Plot de départ compétition

Avec track start
Base inox
310 x 330 mm
1950,00 € HT



H004Z1 - Plot de départ compétition

Base PVC
370 x 400 mm
3000,00 € HT

H004Z1-1 - Avec capteur faux départ

4000,00 € HT



H005Z1 - Plateforme

Avec poignée
500 x 600 mm
580,00 € HT

H005Z2 - Plateforme

Avec poignée et track start
500 x 700 mm
1100,00 € HT

ÉCHELLES, MAINS COURANTES ET ACCESSOIRES



Échelle Ø 43 - Inox 316 - Marche de sécurité - Marche de luxe



Échelle standard asymétrique

G044
2 marches
620,00 € HT

G045
3 marches
710,00 € HT

G046
4 marches
798,00 € HT

G047
5 marches
870,00 € HT



Échelle mixte asymétrique

G060
2 marches
550,00 € HT

G061
3 marches
625,00 € HT

G062
4 marches
680,00 € HT

G063
5 marches
730,00 € HT



Échelle spécial grilles à débordement

G064
2 marches
A = 1460 mm
B = 710 mm
736,00 € HT

G066
4 marches
A = 1960 mm
B = 1210 mm
1050,00 € HT

G065
3 marches
A = 1710 mm
B = 960 mm
1000,00 € HT

G067
5 marches
A = 2210 mm
B = 1460 mm
1100,00 € HT

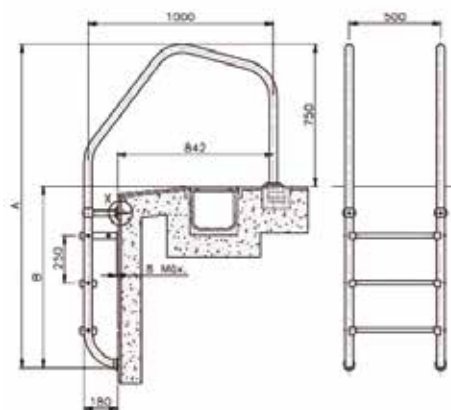

Accessoires pour échelles Ø 43



G094 - Marche de sécurité
Double surface antidérapante
Inox 316
500 x 190 mm
148,00 € HT



G095 - Marche de luxe
Inox 316
500 x 80 mm
77,00 € HT



G113 - Marche
500 x 80 mm
51,30 € HT



G096 - Ancrage droit
Ø 43
170,50 € HT



G097 - Ancrage incliné
Ø 43
156,00 € HT



G100 - Tampons d'échelle
Ø 43 avec rotule
La paire
20,50 € HT



G102 - Visserie
Inox ou polyester
6 vis+6 écrous+6 rondelles
28,00 € HT



ÉCHELLES, MAINS COURANTES ET ACCESSOIRES

Échelle Ø 48
Largeur 550 mm
Inox 316
Marche de sécurité
Marche de luxe



G079
3 marches
1356,00 € HT

G080
4 marches
1560,00 € HT

G081
5 marches
1650,00 € HT

Accessoires pour échelles Ø 48



G092DE - Marche Polyester
500 x 100 mm
Avec visserie
● ○ ●
48,50 € HT



G093DE - Marche Polyester
500 x 150 mm
Avec visserie
52,80 € HT



G092 - Marche Polyester
550 x 90 mm
Sans visserie
57,00 € HT



G093 - Marche Polyester
550 x 140 mm
Sans visserie
90,00 € HT



G098 - Ancre droit
Ø 48
200,00 € HT



G099 - Ancre incliné
Ø 48
150,00 € HT



G101H - Tampon d'échelle oblique
Ø 48
L'unité
13,20 € HT



G101 - Tampon d'échelle
Ø 48
L'unité
4,85 € HT



Main-courantes sur mesure
Inox 316
Nous consulter



Réalisation, rénovation de plongeoirs
et pièces détachées : nous consulter



1
Plongeur sur mesure
Nous consulter

2
66-231-330 - Planche de compétition
Type Maxiflex B
14 900,00 € HT

3
**70-231-524 - Ensemble articulation
arrière et axe de rotation réglable**
Durafirm
11 900,00 € HT



G119ESM - Planche de plongeur
480 x 52 cm
12 700,00 € HT

G119AS - Planche de plongeur
320 x 46,5 cm
1790,00 € HT



93950293 - Butée Delta
Caoutchouc
110 x 95 mm
90,00 € HT le mètre linéaire



LIGNES DE NAGE, ENROULEURS ET ACCESSOIRES

Modèle compétition Moscou
Montée sur câble inox 316 Ø 4 mm
Crochet + tendeur à cliquet aux extrémités



H025-25 - Ligne de nage
Ø 100
25 m
450,00 € HT

H026-50 - Ligne de nage
Ø 100
50 m
840,00 € HT



H027-25 - Ligne de nage
Ø 150
25 m
680,00 € HT

H028-50 - Ligne de nage
Ø 150
50 m
1350,00 € HT

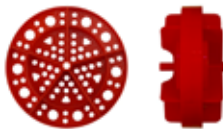

H029C-NM
Disques creux
Ø 100
● ○ ● ●
0,95 € HT

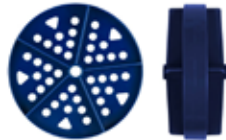

H029
Disques pleins
Ø 100
● ○ ● ●
0,95 € HT



H029C150
Disques creux
Ø 150
● ○ ● ●
2,99 € HT



H103C
Micro donut
32 x Ø 75 mm
● ○ ● ● ●
0,80 € HT



H041OL - Ligne de nage
Câble Ø 4
25 m
310,00 € HT

Modèle entraînement Roma
Monté sur câble inox
Crochet + tendeur latex aux extrémités

H041OL-1 - Ligne de nage
Câble Ø 4
50 m
630,00 € HT

H041OL-2 - Ligne de nage
Corde Ø 6
25 m
310,00 € HT

H041OL-3 - Ligne de nage
Corde Ø 6
50 m
565,00 € HT



H103 - Flotteurs Roma
47 x Ø 75 mm
● ○ ● ● ●
0,80 € HT



H152 - Sac de rangement
Pour ligne de nage de 25 m
PVC haute résistance
150 x 100 x 100 cm
257,50 € HT

H152A
Pour ligne de nage de 50 m
150 x 120 x 120 cm
265,00 € HT

LIGNES DE NAGE, ENROULEURS ET ACCESSOIRES

Lignes enroulables

Montée sur corde ou câble inox

1 mousqueton et 1 tendeur latex aux extrémités

Intercalaires de 20 cm

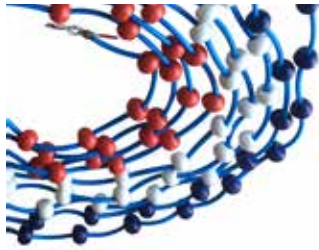

H041G - Ligne de nage avec intercalaires
10,00 € HT le mètre linéaire



H041GE - Ligne de nage Olupso
11,00 € HT le mètre linéaire



H2000L - Flotteur Olupso
70 x Ø 65 mm
● ○ ● ●
1,40 € HT



H050 - Intercalaire
PVC souple
20 cm
● ●
0,80 € HT



H127RON - Rondelle
Nylon
Ø 3 cm x 3 mm
Trou Ø 82 mm
0,75 € HT



H128RON - Rondelle
Nylon
Ø 2,4 cm x 2 mm
Trou Ø 82 mm
0,40 € HT

Coloris des lignes compétitions, entraînements et enroulables Coloris sur demande

25 m

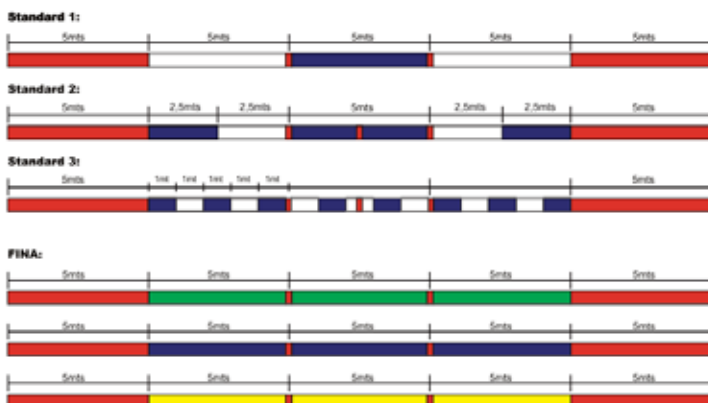

50 m

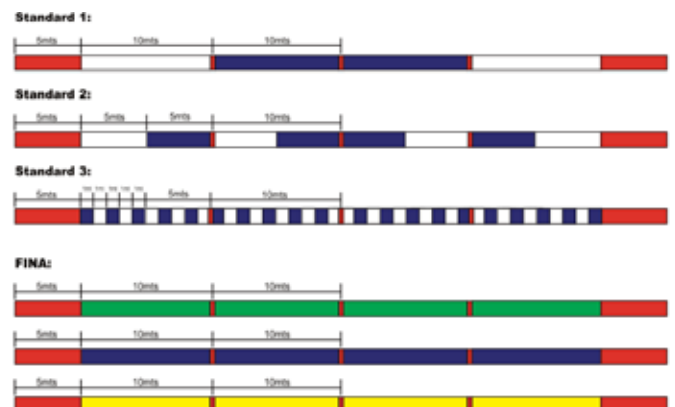



LIGNES DE NAGE, ENROULEURS ET ACCESSOIRES

Inox 316L



H069 - Tendeur inox
Ø 8 mm Ø 10 mm
9,50 € HT 16,00 € HT



H067A - Tendeur à ridoir
65,00 € HT



H067 - Tendeur à cliquet
108,00 € HT



H068 - Clé mixte
19,00 € HT



H067D - Cache tendeur à cliquet
● ●
10,50 € HT



H077C - Tendeur latex
25,00 € HT



H075 - Ressort
42,00 € HT



H066 - Corde Polypropylène
Bobine de 100 m
Ø 6 42,00 € HT
Ø 8 52,00 € HT
Ø 12 88,00 € HT



H109A - Mousqueton pompier à œil
Ø 8
5,00 € HT



H112 - Cosse coeur
Ø 4 0,70 € HT
Ø 5 0,85 € HT
Ø 6 0,95 € HT



H074C - Crochet LPC
Ø 4 3,60 € HT
Ø 5 4,20 € HT
Ø 6 4,80 € HT

Inox



H131 - Serre-câble étrier
Ø 4 3,25 € HT
Ø 5 5,60 € HT
Ø 6 8,00 € HT



H116 - Serre-câble simple
Ø 4 2,75 € HT
Ø 5 5,40 € HT
Ø 6 6,60 € HT



H076 - Serre-câble double
Ø 4 4,50 € HT
Ø 5 6,85 € HT
Ø 6 9,25 € HT

Inox



Câble gainé H062
Ø 3 - 4 mm
26 m
53,00 € HT

H06251
Ø 3 - 4 mm
51 m
104,00 € HT

Câble H0621
Ø 4 mm
26 m
58,00 € HT

H06215
Ø 4 mm
50 m
104,00 € HT

H065G26
Ø 4 - 6 mm
26 m
60,00 € HT

H065G1-51
Ø 4 - 6 mm
51 m
105,00 € HT

Inox

LIGNES DE NAGE, ENROULEURS ET ACCESSOIRES

Autres pièces détachées nous consulter
Inox



H079 - Coupe à sceller standard
120,00 € HT



H080 - Coupe à sceller avec crochet escamotable
118,50 € HT



16600 - Ancre à encastrer
108,00 € HT

Inox
Ø 48 mm sur demande



H081 - Support de ligne de nage
17 cm x Ø 43 mm
70,00 € HT



H081-2A - Support ligne de nage
Double anneau
17 cm x 43 mm
75,00 € HT



N188 - T pour couloir de jeu
Double anneau
50 cm x 20 cm x Ø 43 mm
200,00 € HT



H083 - Ventouse simple
Ø 120 mm
10,80 € HT



H084 - Ventouse double
Ø 120 mm
18,00 € HT



HBO084 - Ventouse double
Ø 120 mm
78,00 € HT



Guide de ligne de nage
H025GU
Adaptable à tous types de murets
PVC
170 mm
260,00 € HT



H025GUL
380 mm
350,00 € HT

LPC-AP - Attache perche
20 cm 115,00 € HT
25 cm 118,00 € HT
30 cm 120,00 € HT



LIGNES DE NAGE, ENROULEURS ET ACCESSOIRES

Inox 304
Roues en option

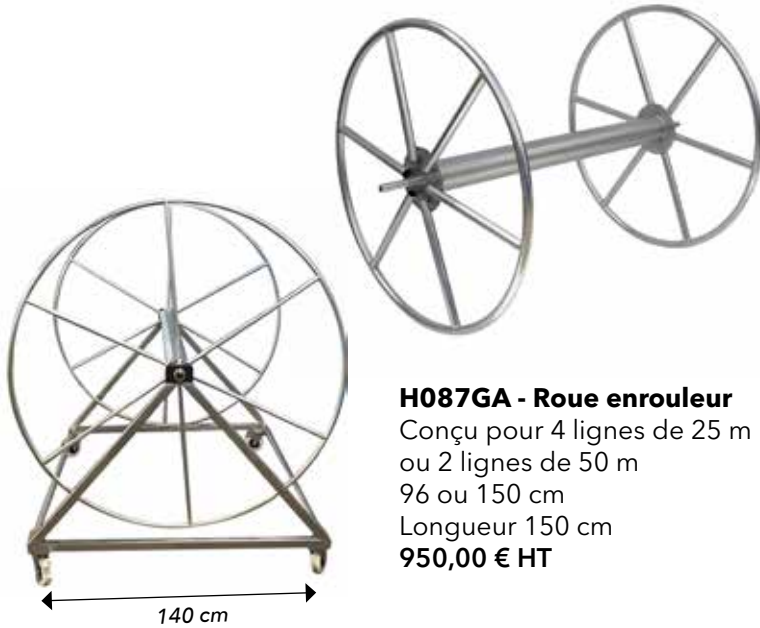

H087GA - Roue enrouleur
Conçu pour 4 lignes de 25 m
ou 2 lignes de 50 m
96 ou 150 cm
Longueur 150 cm
950,00 € HT



H087GB - Base enrouleur
800,00 € HT

Aluminium
Roues en option
Vendu vide



H086 - Enrouleur standard mini
Conçu pour 2 lignes Ø 100 de 25 m
80 x 140 x 135 cm
1700,00 € HT

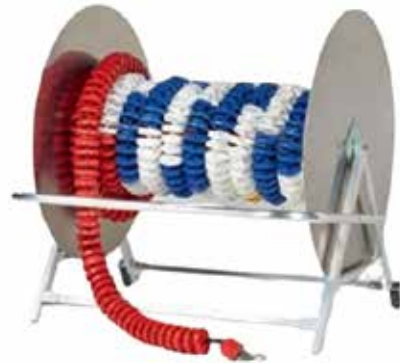

H087 - Enrouleur standard maxi
Conçu pour 4 lignes Ø 100 de 25 m
140 x 135 x 139 cm
1899,00 € HT

Aluminium
Roues 4 roues dont 2 avec frein
Vendu vide

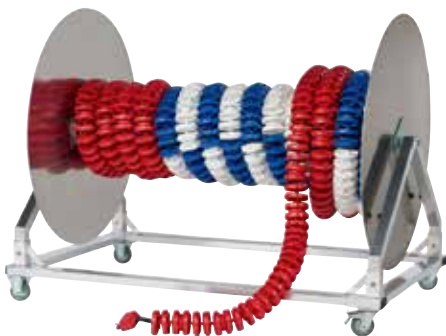

H088 - Enrouleur luxe mini
Conçu pour 3 lignes d'eau Ø 150 mm de 50 m
ou 6 lignes d'eau Ø 100 mm de 25 m
178 x 118 x 137 cm
2010,00 € HT

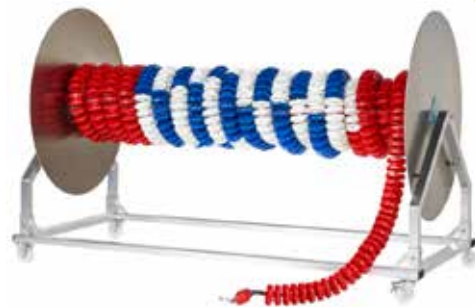

H089 - Enrouleur luxe maxi
6 lignes d'eau Ø 150 mm de 25 m
ou 12 lignes d'eau Ø 100 de 50 m.
245 x 118 x 150 cm
2750,00 € HT

SIGNALISATION VIRAGE DOS ET FAUX DÉPART

Inox 316

Hauteur 180 cm

Équipé d'une poulie et d'un élément de
fixation et de libération rapide de la corde



ÉQUIPEMENTS

H052 - Montants faux départ

Ø 43 mm

Lot de 2

350,00 € HT

H057/2 - Montants virage dos

Ø 43 mm

Lot de 2

300,00 € HT

H057/2 - Montants virage dos

Ø 48 mm

Lot de 2

300,00 € HT

H053 - Montants faux départ

Ø 48 mm

Lot de 2

450,00 € HT

H057 - Montants virage dos

Ø 43 mm

Lot de 4

470,00 € HT

H057 - Montants virage dos

Ø 48 mm

Lot de 4

470,00 € H



H056 - Ligne de flotteurs faux départ

Corde polyester

Flotteurs rouges polypropylène

12,00 € HT le mètre linéaire



H061 - Banderole virages dos

Fanions triangulaires ou rectangulaires

Coloris sur demande

Logo en option

À partir de 3,00 € HT le mètre linéaire



PANNEAUX ET PLAQUES SIGNALÉTIQUES

Stratifié compact 11 mm
36 x 30 x 15 cm
Texte noir recto verso
Fond coloré selon disponibilité

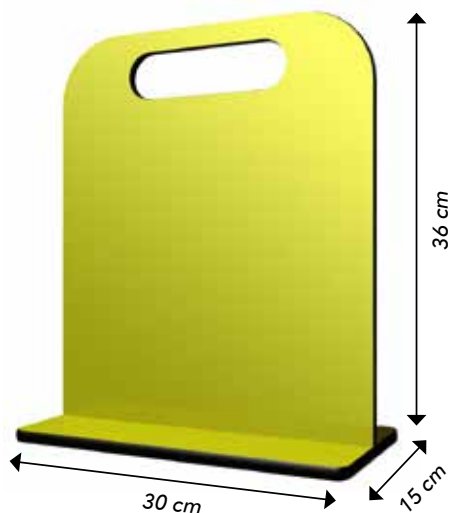

- | | | | |
|-----------------|--|------------------|-----------------------------------|
| I065ST0 | Sans texte | I065ST4 | Couloir nageurs confirmés |
| I065ST1 | Couloir réservé | I065ST2 | Couloir nage avec palmes |
| I065ST8 | Veillez nager à droite | I065ST30 | Couloir nageurs lents |
| I065ST7 | Couloir réservé au club | I065ST38 | Nageurs tranquilles |
| I065ST6C | Couloir réservé au club - associations | I065ST37 | Nageurs moyens |
| I065ST6 | Couloir réservé aux associations | I065ST36 | Nageurs rapides |
| I065ST5 | Couloir réservé aux leçons | I065ST45 | Nage rapide - Matériels autorisés |
| I065ST28 | Couloir réservé PMR | I065ST12 | Matériel autorisé |
| I065ST27 | Couloir réservé aux enfants | I065ST19 | Réservé à l'Aquabike |
| I065ST2 | Couloir réservé débutants | I065ST18 | Réservé activités Aquagym |
| I065ST24 | Couloir réservé nages régulières | I065ST44 | Détente et enfants |
| I065ST23 | Couloir réservé nages rapides | I065ST31 | Location vélos |
| I065ST17 | Couloir réservé à la brasse | I065ST21 | Zone de plongoir |
| I065ST16 | Couloir réservé au crawl | I065ST32 | Plongoir fermé |
| I065ST15 | Couloir réservé au public | I065ST29 | Pataugeoire fermée |
| I065ST14 | Couloir réservé aux animations | I065ST43 | Douche obligatoire |
| I065ST13 | Couloir réservé aux scolaires | I065ST43S | Douche et savonnage obligatoires |
| I065ST3 | Couloir réservé aux nageurs | I065ST39 | Interdit de plonger |
| I065ST4 | Couloir baignade libre | I065ST42 | Ne pas monter sur le muret |
| I065ST40 | Couloir nageurs loisirs | | |

72,00 € HT

50 x 40 x 15 cm

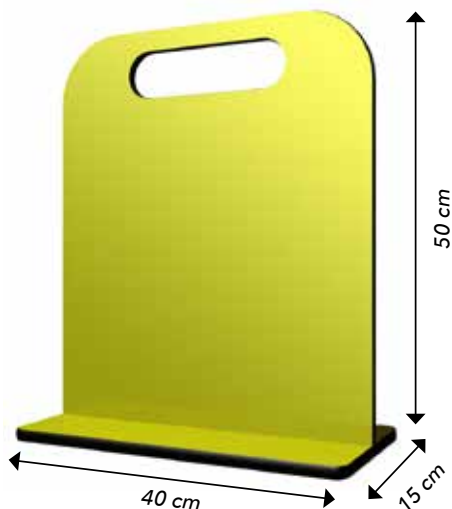

- | | | | |
|-----------------|---|-----------------|-------------------------------------|
| I065ST20 | Interdit de plonger : faible profondeur | I065ST35 | Attention Grande Profondeur |
| I065ST22 | Attention Nettoyage en cours | I065ST25 | Toboggan Interdit aux plus de 5 ans |
| I065ST10 | Attention Sol glissant | | |
| I065ST11 | Espace jeux | | |

85,00 € HT

PANNEAUX ET PLAQUES SIGNALÉTIQUES

Texte recto
Support PVC 5 mm
250 x 100 mm
Coloris ● ●



**PETIT
BASSIN**

I055 - Petit bassin
29,00 € HT

**GRAND
BASSIN**

I056 - Grand bassin
29,00 € HT

Texte recto
Support PVC 5 mm
600 x 100 mm
Coloris ● ●



PROFONDEUR 0.90 M

PROFONDEUR 2.00 M

I054 - Profondeur
Personnalisable
46,00 € HT

Dimensions et textes sur mesure nous consulter



JEUX EXTÉRIEURS INTERDITS AUX PLUS DE 8 ANS

PATAUGEoire RÉSERVÉE AUX MOINS DE 5 ANS

DÉFENSE DE FUMER SUR LES PLAGES

**PHOTOS
ET VIDEOS
INTERDITES**

Stade Nautique Yuri Gagarine

Logo: **SNYG** (Stade Nautique Yuri Gagarine) and **Grand Orlyseine Bievre**

- Maillot de bain obligatoire
- Bonnet obligatoire sur les bassins intérieurs  
- Sous vêtement interdit 
- Short de bain interdit
- Un adulte pour trois enfants de moins de 10 ans maximum
- Interdit aux enfants de moins de 10 ans non accompagnés 
- Les enfants sont sous la responsabilité de leurs parents
- Alcool interdit 
- Chicha interdit 





HORLOGES ET COMPTES SECONDES

NOUVEAU



H094A - Horloge autonome

Fonctionne à l'énergie solaire et lumineuse
Fabriquée à partir de matériaux recyclés
Visibilité jusqu'à 20 m

Ø 32 cm



600,00 € HT

Cadran et lunette en ABS
Verre minéral
Piles AA non incluses



1116AC - Horloge IP65

Visibilité jusqu'à 40 m
Ø 60 cm



205,00 € HT



H129A - Horloge IP54

Visibilité jusqu'à 15 m
Ø 25 cm



100,00 € HT



H129 - Horloge radiopilotée

Lunette aluminium brossé
Visibilité jusqu'à 35 m

Ø 50 cm



150,00 € HT

NOUVEAU



H094B - Horloge affichage 5 cm 510,00 € HT

H094C - Horloge affichage 7 cm 720,00 € HT



H091A - Horloge/Calendrier IP54

Boîtier ABS et verre plexiglas
830 x 230 x 40 mm

1,5 kg

165,00 € HT



H091 - Horloge radiopilotée IP54

Composite métal/plastique
Doigt de gant en option

250 x 250 x 60 mm

1,28 kg

110,00 € HT

HORLOGES ET COMPTES SECONDES

Départ cadencé toutes les 15 s
1 m de câble inclus Éclairage en option

NOUVEAU



H092 - Compte-secondes IP65

Cadre aluminium laqué
Verre plexiglas
625 x 625 x 80 mm
5 kg
920,00 € HT



H092BCEXT - Compte-secondes IP65

Cadre aluminium laqué
Verre plexiglas
1000 x 1000 x 120 mm
24,5 kg
1360,00 € HT



H092B - Compte-secondes IP54

Sans cadre ni verre
1000 x 1000 x 80 mm
7 kg
485,00 € HT



H092A - Compte-secondes IP54

Cadre ABS
Verre minéral
505 x 80 mm
3,6 kg
650,00 € HT

H133 - Transformateur

220V - 24V
150,00 € HT

H092-MOT - Moteur

170,00 € HT



H092PC - Compte-secondes portable

Boîtier ABS et verre plexiglas
57 x 45 x 19 cm - cadran Ø 37 cm
3,6 kg
460,00 € HT



NOUVEAU

ESSENCES DE HAMMAM			
S063-2	Vanille Bourbon	5 L	118,00 €
S063-1	Vanille Bourbon	1 L	30,00 €
S065-2	Mangue	5 L	118,00 €
S065-1	Mangue	1 L	30,00 €
S061-2	Lilas	5 L	138,00 €
S061-1	Lilas	1 L	36,00 €
S028EL6	Menthe	6 L	85,00 €
S026B	Orange Mandarine	5 L	150,00 €
S026	Orange Mandarine	1 L	41,00 €
S025B	Eucalyptus de Chine	5 L	153,00 €
S025	Eucalyptus de Chine	1 L	41,00 €
S028B	Eucalyptus Menthol	5 L	141,00 €
S028	Eucalyptus Menthol	1 L	38,00 €
S025-6L	Eucalyptus	6 L	85,00 €



NOUVEAU

ESSENCES DE SAUNA			
S062-2	Vanille Bourbon	5 L	116,00 €
S062-1	Vanille Bourbon	1 L	28,00 €
S064-2	Papaye	5 L	173,00 €
S064-1	Papaye	1 L	46,00 €
S060-2	Lilas	5 L	137,00 €
S060-1	Lilas	1 L	33,00 €
S009B	Orange Mandarine	5 L	143,00 €
S009	Orange Mandarine	1 L	35,00 €
S002B	Eucalyptus de Chine	5 L	145,00 €
S002	Eucalyptus de Chine	1 L	36,00 €
S0035L	Eucalyptus Menthol	5 L	128,00 €
S003	Eucalyptus Menthol	1L	30,00 €

POÊLES ÉLECTRIQUES

Branchement triphasé 400 V
Unité de contrôle et pierres non incluses
IPX4



HSE090400 - Poêle Senator
9 kW - 8 à 14 m³
Fonctionne avec une unité C150
Capacité 40 kg de pierres
46,5 x 66 x 34,5 cm
930,00 € HT



Poêle Club
Fonctionne avec une unité C150
Capacité 60 kg de pierres
50,5 x 70 x 43 cm

HRKG110400
11 kW - 9 à 16 m³
1200,00 € HT

HRKG135400
13,5 kW - 11 à 20 m³
1300,00 € HT

AZ001 - Unité de commande C150
Conçu pour les poêles 2,3 à 17 kW
Réglage de la température 40 et 110°C
Durée de fonctionnement 4 h
Programmable 0 à 12 h
658,00 € HT

HRHG150400
15 kW - 14 à 24 m³
1450,00 € HT

S014 - Pierres volcaniques
Carton de 20 kg - Ø 10-15 cm
30,00 € HT



EL5006 - Applique longue
230 x 330 x 155 cm
32,00 € HT



EL5007 - Grande applique
280 x 300 x 185 cm
33,00 € HT



EL5001 - Applique d'angle
230 x 210 x 230 cm
45,00 € HT



EL5010 - Applique d'angle
310 x 240 x 170 mm
51,00 € HT



85733 - Grille de ventilation rectangulaire
315 x 130 x 17 mm
24,50 € HT



85741 - Grille de ventilation carrée
315 x 140 x 130 x 17 mm
18,00 € HT



Poignées
Nous consulter



S018 - Thermomètre droit
25,00 € HT



S018R - Thermomètre rond
Ø 155 mm
37,00 € HT



S017 - Thermomètre hygromètre
Ø 155 mm
41,00 € HT



S036 - Bracelets journaliers
Usage unique
25 x 250 mm
Coloris nous consulter
Lot de 1000 d'un même coloris
75,00 € HT



S015P-NM - Seau intérieur
Pour réf. S015-NM
7,00 € HT



S015-NM - Seau en bois
Bois de mélèze
5 L
61,50 € HT



S015M - Seau mural en bois
Bois de mélèze
5 L
460,00 € HT



S016 - Louche en bois
40 cm
11,50 € HT





Mobilier

Accueil et terrasse
Bains de soleil
Rangement fixe
Rangement mobile
Stratifié compact
Utilitaires





100 % RECYCLÉS



RE03-2 - Chaise Palma

55 x 62 x 84 cm



25,00 € HT

RE03-3 - Table Olot

140 x 90 x 73 cm



99,00 € HT

RE03-4 - Table Tossa

Ø 86 x 73 cm



55,00 € HT



100 % RECYCLÉS



1
RE06-6 - Chaise Baku
 66,7 x 59,5 x 78,5 cm
 ○ ●
91,00 € HT

2
RE03-3 - Table Monaco
 60 x 60 x 45 cm
 ○ ●
36,00 € HT

1 + 2
RE03-3 - Set Baku/Monaco
 2 chaises + 1 table
 ○ ●
190,00 € HT



RE03-8 - Chaise Play
 54 x 57 x 78,6 cm
 ● ● ● ● ●
42,00 € HT



RE03-1 - Chaise Delta
 53,8 x 55 x 80,8 cm
 ● ● ● ● ●
35,00 € HT



RE03-9 - Chaise Garrotxa
 52 x 43,6 x 89 cm
 ●
29,00 € HT



ACCUEIL ET TERRASSE



U018 - Parasol

Toile 180 g/m²
8 baleines Ø 2 m
Mât Ø 29 à 32 mm

●
78,00 € HT

U018B - Parasol

Toile 220 g/m²
6 baleines Ø 2,5 m
Mât Ø 35 à 38 mm

●
170,00 € HT



U021A - Pied de parasol lesté

Base ciment et tube fer époxy
Pour mât Ø 30 à 38 mm
36 x 26 x 30 cm
11 kg

●
45,00 € HT



U021B - Pied de parasol à lester

13 L d'eau ou 18 kg de sable
Pour mât Ø 18 à 33 mm
Ø 43 x 26 cm

○
49,00 € HT

BAINS DE SOLEIL



U001 - Bain de soleil

Inclinable sur 5 positions
Roues arrière
188 x 63 x 47 cm
10,3 kg

○ ●
90,00 € HT



RE002 - Bain de soleil Sky

Inclinable sur 5 positions
Dossier avec butée de sécurité
Roulettes sur pieds arrière
Cales anti-dérapantes à l'avant et à l'arrière
195 x 77 x 37 cm
13,7 kg

○ ● ou ○ ●
295,00 € HT

RANGEMENT FIXE

Vendus vides
PVC
Coloris



N049-2 - Range-tapis mini
3 compartiments
105 x 73 x 230 cm
475,00 € HT



N049-1 - Range-tapis maxi
6 compartiments
200 x 70 x 230 cm
830,00 € HT



N049R - Range-tapis maxi
6 compartiments
200 x 70 x 230 cm
988,00 € HT

PVC
Coloris



N001-1 - Rayonnage 60 cm
100 x 60 x 195 cm 398,00 € HT
150 x 60 x 195 cm 488,00 € HT
200 x 60 x 195 cm 600,00 € HT

N002 -1 - Rayonnage 50 cm
100 x 50 x 195 cm 314,00 € HT
150 x 50 x 195 cm 425,00 € HT
200 x 50 x 195 cm 520,00 € HT

Aluminium
Coloris



Étagère à chaussures 3 niveaux
R074SM 180 x 30 x 102 cm 600,00€ H
R074S 200 x 30 x 102 cm 650,00€ H



R073 - Étagère à chaussures 5 niveaux
200 x 30 x 170 cm
990,00 € HT



RANGEMENT MOBILE

Vendus vides
4 roues dont 2 avec frein
PVC
Coloris unique ●



050CP04 - Coffre de rangement
120 x 70 x 94 cm
850,00 € HT



N025AC - Chariot avec couvercle
120 x 70 x 93 cm
845,00 € HT

N025SC - Sans couvercle
120 x 70 x 93 cm
640,00 € HT



N026 - Chariot porte-équipements
21 crochets
138 x 60 x 175 cm
785,00 € HT



050CP12000 - Chariot mixte
138 x 60 x 145 cm
705,00 € HT

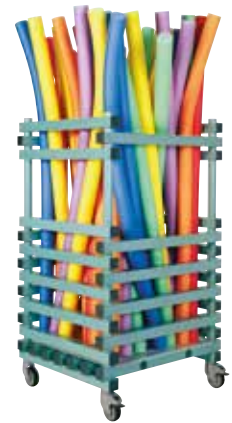

N024R - Chariot à frites
80 x 70 x 135 cm
699,00 € HT



N066APMR - Chariot à 3 portes
3 compartiments
3 cadenas inclus
120 x 60 x 175 cm
1680,00 € HT

N027A - Chariot à bacs
138 x 60 x 180 cm
680,00 € HT





Vendus vides
4 roues dont 2 avec frein
PVC
Coloris



N023-1 - Chariot à frites
100 x 50 x 96 cm
310,00 € HT

N024-1 - Chariot à frites
100 x 50 x 130 cm
305,00 € HT



N076-1 - Chariot à haltères
140 x 40 x 125 cm
405,00 € HT



GF031-1 - Chariot à palmes
6 roues dont 2 avec frein
140 x 60 x 115 cm
405,00 € HT



CP46001 - Portant à gilets
120 x 80 x 180 cm
790,00 € HT



N078C-1 - Chariot à planches et ceintures
140 x 60 x 180 cm
405,00 € HT



N078G-1 - Chariot à planches et ceintures
140 x 60 x 180 cm
485,00 € HT



RANGEMENT MOBILE



N056-4 - Chariot de rangement mini
Sans couvercle
100 x 87 x 80 cm
340,00 € HT



N056-3 - Chariot de rangement mini
Avec couvercle
100 x 87 x 80 cm
425,00 € HT

Vendus vides
Cadenas et chaîne en option
4 roues dont 2 avec frein
PVC
Coloris



N056-2 - Chariot de rangement maxi
6 roues dont 2 avec frein
Sans couvercle
200 x 87 x 80 cm
525,00 € HT



N056-1 - Chariot de rangement maxi
6 roues dont 2 avec frein
Avec couvercle
200 x 87 x 80 cm
650,00 € HT



N066-1 - Chariot 2 portes
140 x 82 x 152 cm
650,00 € HT



N066-2 - Chariot à 3 portes
140 x 82 x 205 cm
990,00 € HT

RANGEMENT MOBILE

Vendus vides
4 à 6 roues dont 2 avec frein
PVC
Coloris



N077-1 - Chariot à bacs
140 x 60 x 205 cm
510,00 € HT



N077-3 - Chariot 6 bacs
102 x 76 x 180 cm
490,00 € HT



N077-2 - Chariot 3 bacs
55 x 66 x 180 cm
380,00 € HT



**LPCPVC002 - Chariot à bacs
et frites centrales**
150 x 66 x 145 cm
975,00 € HT



**LPCPVC001 - Chariot à bacs
et frites latérales**
150 x 66 x 145 cm
875,00 € HT



N048AA - Roue avec frein
Ø 10 mm
17,00 € HT



N048A - Roue sans frein
Ø 10 mm
15,00 € HT



RANGEMENT MOBILE

Vendus vides
Roues en option N058A



N059 - Range noddles
Roues non incluses
80 x 40 x 130 cm
18 kg
À l'unité
390,00 € HT



N058 - Aquatic box
Roues non incluses
80 x 40 x 45 cm
15 kg
À l'unité
445,00 € HT

*Exemple de
présentation
avec 3 modules*

Chariot sur roues



N038
60 x 40 x 40 cm
125,00 € HT



N038-2
60 x 40 x 80 cm
155,00 € HT



N038-3
60 x 40 x 120 cm
185,00 € HT



N053BR - Caisse palette 550 L
En PVC gris
4 roues
1200 x 800 x 925 mm
Capacité 285 litres
425,00 € HT



N023GI - Pannière haute
66,5 x 46 x 85 cm - 180 L
172,00 € HT



N038P - Plateau roulant
4 roues dont 2 pivotantes
ABS et caoutchouc
61,6 x 41,6 x 17,2 cm
62,00 € HT

STRATIFIÉ COMPACT

Stratifié compact 10 mm
Intérieur personnalisable
Pieds en option
Coloris

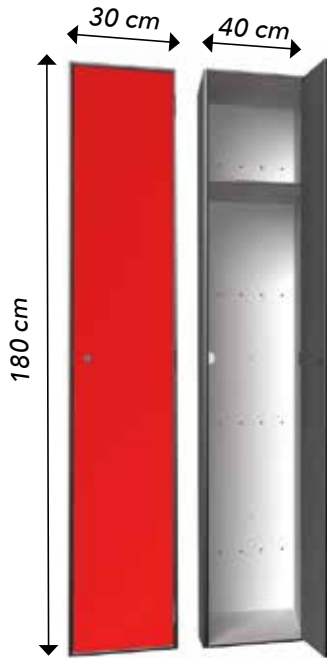

RCC1P - Armoire maître-nageur
180 x 30 x 50 cm
600,00 € HT

RCC1PL - Armoire maître-nageur
180 x 40 x 50 cm
650,00 € HT

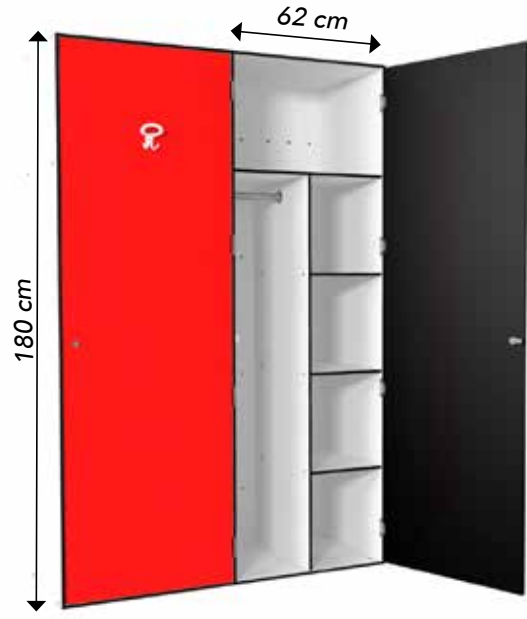

RCC1PMN - Armoire maître-nageur
180 x 60 x 50 cm
980,00 € HT



N081A - Armoire de bureau
6 étagères
180 x 120 x 40 cm
1050,00 € HT



N081B - Armoire de bureau basse
4 étagères
100 x 120 x 40 cm
800,00 € HT



N079F - Bureau maître-nageur
Niche avec 1 étagère
Pieds en option
120 x 70 x 72 cm
575,00 € HT



STRATIFIÉ COMPACT

Stratifié compact 10 mm
Pieds en option

Coloris 

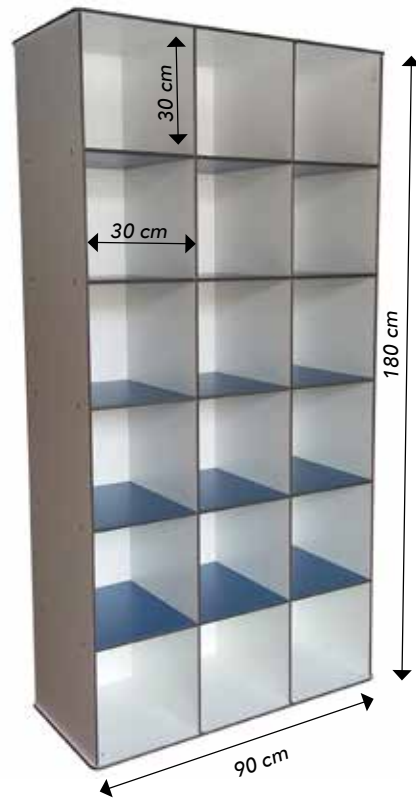

N08012C - Étagère 12 cases

100 x 75 x 30 cm

650,00 € HT

N08016C - Étagère 16 cases

100 x 100 x 30 cm

775,00 € HT

N08018C - Étagère 18 cases

180 x 90 x 35 cm

990,00 € HT



N08020C - Étagère 20 cases

4 roues dont 2 avec frein

158 x 125 x 52 cm

1350,00 € HT

N08025C - Étagère 25 cases

4 roues dont 2 avec frein

158 x 156 x 52 cm

1500,00 € HT

N08040C - Étagère 40 cases

200 x 125 x 30 cm

1500,00 € HT



N040STRAT1 - Banc 12 cases

4 roues

150 x 40 x 40 cm

590,00 € HT

N040STRAT6 - Banc 6 cases

4 roues

100 x 40 x 40 cm

500,00 € HT

STRATIFIÉ COMPACT

Stratifié compact 10 mm

Coloris 



N040STRAT - Banc coffre

4 roues
150 x 40 x 40 cm
600,00 € HT

Serrures Ojmar en option p. 81



CA001 - Serrure came batteuse droite

Barillet à paillettes
2 clés plates incluses
18,50 € HT



R001 - Pied de cabine

Réglable 14 à 17 cm
Nylon option inox
Coloris 
25,00 € HT



CA009 - Serrure cadennassable droite

Came et cadenas non inclus
15,00 € HT



R001M - Pied de cabine

Réglable 9 à 13 cm
Nylon option inox
Coloris 
30,00 € HT

R001CA - Pied de casier

Aluminium
14 à 17 cm
27,00 € HT

UTILITAIRES



U007 - Barrière V1200

126 x 102 x 5 cm
Pieds 48 cm
6,5 kg

90,00 € HT



U007 - Barrière V2000

198 x 102 x 5 cm
Pieds 55,5 cm
9,2 kg

102,50 € HT





Vestiaires

Casiers et accessoires
Bancs et patères
Serrures et accessoires
Sèche-cheveux
Tables à langer et chaises hautes

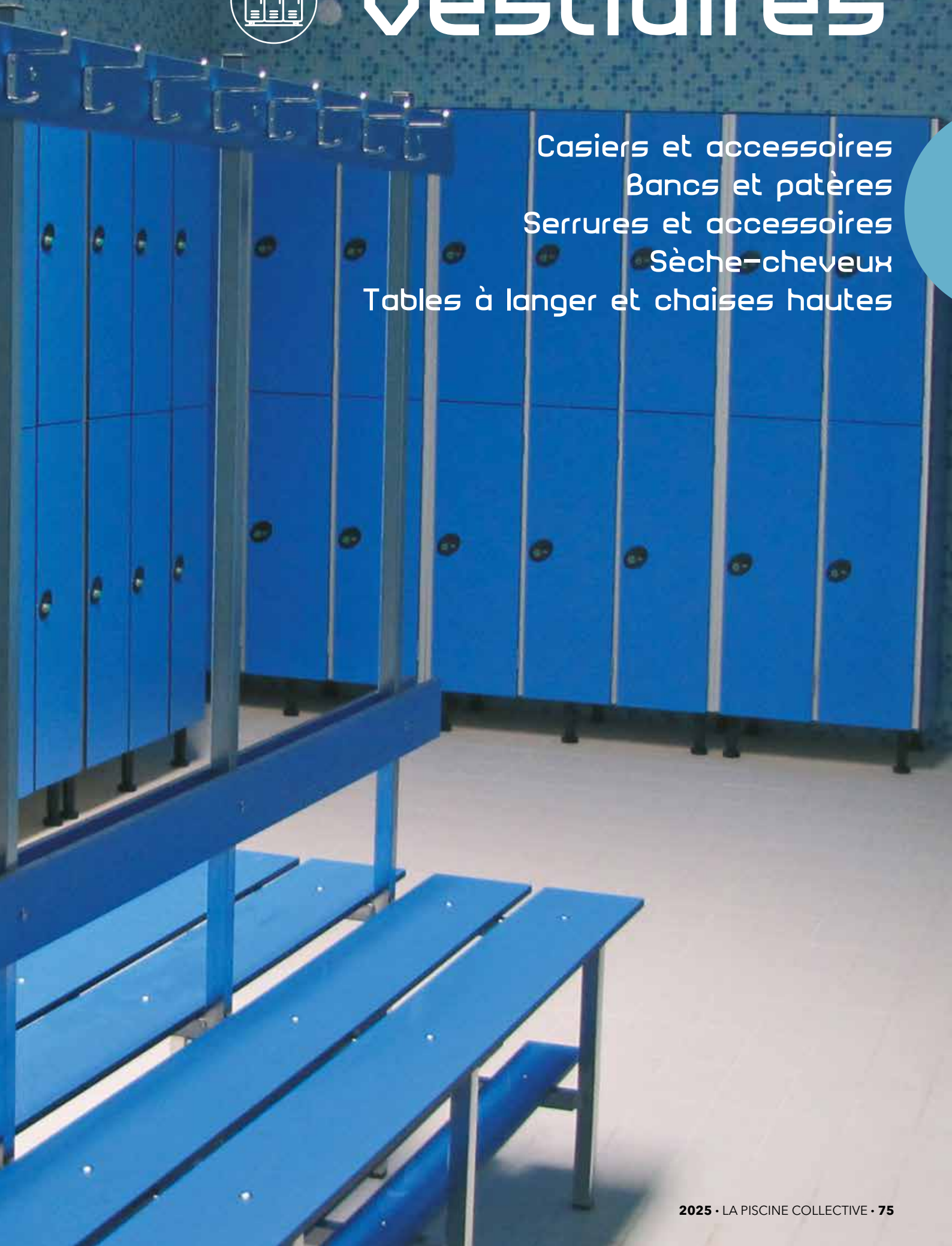



CASIERS ET ACCESSOIRES

Stratifié compact 10 mm

Serrures en option p. 81

Pieds en option

Coloris

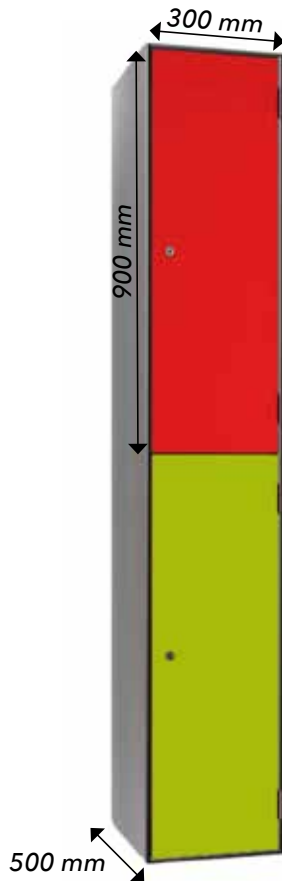

Colonne avec 2 casiers

RCC2P

180 x 30 x 50 cm

475,00 € HT

RCC2P400

180 x 40 x 50 cm

550,00 € HT

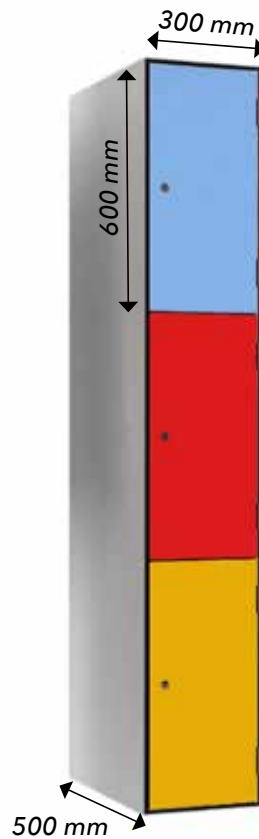

Colonne avec 3 casiers

RCC3P

180 x 30 x 50 cm

500,00 € HT

RCC3P400

180 x 40 x 50 cm

550,00 € HT

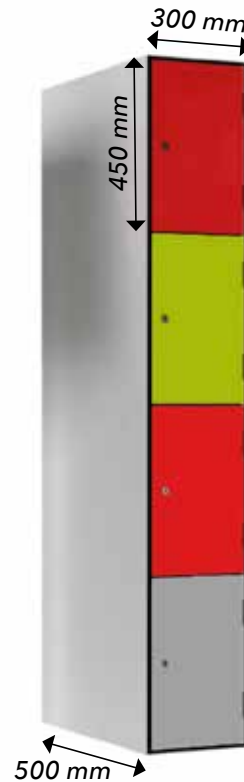

Colonne avec 4 casiers

RCC4P

180 x 30 x 50 cm

550,00 € HT

RCC4P400

180 x 40 x 50 cm

575,00 € HT



R001CA - Pied de casier

Aluminium

14 à 17 cm

27,00 € HT



FABRIQUÉ
EN FRANCE



R065FB - Miroir plat

Fibre de bois et plexi+

366 x 466 x 19 mm

289,00 € HT

CASIERS ET ACCESSOIRES

Nylon option inox

Coloris ○ ● ●



R001 - Pied de cabine
Réglable 14 à 17 cm
25,00 € HT



R001M - Pied de cabine
Réglable 9 à 13 cm
30,00 € HT



R004EN - Équerre murale
12,00 € HT



R044PIN10 - Pince murale
24,00 € HT



R003NOBL - Verrou à voyant
30,00 € HT



R002 - Bouton double
Vis incluses
Ø 50 mm
25,00 € HT



R004 - Paumelle droite
R004G - Paumelle gauche
25,00 € HT



R064 - Charnière
Inox
9,50 € HT



R064R - Charnière avec ressort
Inox
15,00 € HT



CA008 - Gâche de serrure
Inox
5,00 € HT



H068CF - Clé pour verrou
Carré de 8 mm
Inox
12,00 € HT



BANCS ET PATÈRES

Structure tubulaire inox électropoli 30 x 30 mm
Lames en stratifié compact 12 mm
Vis inox

Coloris



Banc simple 2 fonctions

N085/140

140 x 36 x 46 cm
290,00 € HT

N085/180

185 x 36 x 46 cm
390,00 € HT

N085/200

200 x 36 x 46 cm
430,00 € HT

N085/280

280 x 36 x 46 cm
570,00 € HT



Banc double 3 fonctions

N085D/140

140 x 77 x 82 cm
650,00 € HT

N085D/185

185 x 77 x 82 cm
860,00 € HT

N085D/200

200 x 77 x 82 cm
950,00 € HT

N085D/280

280 x 77 x 82 cm
1280,00 € HT



Banc double 4 fonctions

N085D/140

140 x 77 x 176 cm
790,00 € HT

N083D/185

185 x 77 x 176 cm
1050,00 € HT

N083D-200

200 x 77 x 176 cm
1150,00 € HT

N083D/280

280 x 77 x 176 cm
1550,00 € HT



RSBT - Banc mural

280 cm maximum par section
Supports inclus

140,00 € HT le mètre linéaire

RSBTP1 - Support de banc

Inox 316

Structure tubulaire 50 x 30 mm

85,00 € HT



BANCS ET PATÈRES

PVC

Coloris ○ ●



N009-1 - Banc modulaire

40 x 45 cm

● uniquement

150,00 € HT le mètre linéaire



Banc simple LPCPVC

100 x 40 x 50 cm

140,00 € HT

150 x 40 x 50 cm

210,00 € HT

200 x 40 x 50 cm

230,00 € HT



Banc simple avec rangement chaussures N009EC

100 x 40 x 50 cm

140,00 € HT

150 x 40 x 50 cm

170,00 € HT

200 x 40 x 50 cm

200,00 € HT



Banc simple avec patères et rangement chaussures

N069-100

100 x 56 x 185 cm

300,00 € HT

N069-200

200 x 56 x 185 cm

490,00 € HT

N069-150

150 x 56 x 185 cm

430,00 € HT



Banc double avec patères et rangement

N070

100 x 88 x 185 cm

385,00 € HT

200 x 88 x 185 cm

610,00 € HT

150 x 88 x 185 cm

515,00 € HT



BANCS ET PATÈRES

Stratifié compact



R062M - Lisse porte patère

6 patères PVC
100 x 10 cm
75,00 € HT



R061M - Lisse porte patère

4 patères inox
16 cm de haut
Au mètre linéaire
85,00 € HT



R055 - Patère

Acier époxy
140 x 40 mm
○
8,00 € HT

R055-1

●
8,00 € HT



NL002 - Patère

Nylon
145 x 23 x 80 mm
○
19,00 € HT

NL002N

●
19,00 € HT



N043 - Patère

double tête
Nylon
78 x 80 x 42 mm
○
9,00 € HT



N016N-1 - Patère

Nylon
Ø 53 x 37 mm
○ ● ●
14,00 € HT



R0010 - Patère

Aluminium
51,5 x 18 x 65 mm
○ ● ●
8,00 € HT



N016A - Patère

Inox
9,00 € HT

SERRURES ET ACCESSOIRES

Standard Ojmar



Serrure à pièce standard Ojmar

Canon interchangeable
2 clés standard incluses

Q001NM
Droite
47,00 € HT

Q002NM
Gauche
47,00 € HT



Serrure à carte/pièce standard

Canon interchangeable
2 clés standard incluses

Q005NM
Droite
66,00 € HT

Q006NM
Gauche
55,00 € HT



Q013 - Clé Standard
8,40 € HT



Q014 - Clé Pass
10,00 € HT



Q015 - Clé Extraction
10,00 € HT



Canon standard interchangeable
2 clés standard incluses

Q009
Droite
30,00 € HT

Q010
Gauche
30,00 € HT

Sûreté Ojmar



Serrure à pièce sûreté Ojmar

Canon interchangeable
2 clés sûreté incluses

Q003NM
Droite
55,50 € HT

Q004NM
Gauche
55,50 € HT



Serrure à carte/pièce sûreté

Canon interchangeable
2 clés sûreté incluses

Q007-NM
Droite
74,00 € HT

Q008NM
Gauche
74,00 € HT



Q016 - Clé Sûreté
10,80 € HT



Q017 - Clé Pass
12,50 € HT



Q018 - Clé Extraction
12,50 € HT



Canon sûreté interchangeable
2 clés sûreté incluses

Q011
Droite
33,50 € HT

Q012
Gauche
33,50 € HT



Q052 - Jetons métalliques

Lot de 500 349,00 € HT
Lot de 1000 698,00 € HT



BRACELETS DE VESTIAIRE ET POCHE DE PROTECTION

NOUVEAU



Q054-1 - Bracelet LPC

Non compatible avec les poches Q048
Cuir JafTex
330 x 12 x 1,8 mm



Sans numéro 1,50 € HT
Numéro consécutif 3,20 € HT
Numéro non consécutif 3,50 € HT



Q030 - Bracelet Ojmar non numéroté

Poche de protection ABS
Polyuréthane
Bouche inox
265 x 2 x 15 mm



4,60 € HT

Q030N - Bracelet Ojmar numéroté

5,50 € HT



Q048 - Poche de protection non numérotée

Non compatible avec les bracelets Q054-1
1,65 € HT



Q048NO - Poche de protection numérotée

Non compatible avec les bracelets Q054-1
1,80 € HT

PVC
25 x 15 x 10 mm
Coloris ●



Q038B - Poche de protection

Ojmar non numérotée
3,80 € HT



Q038 - Poche de protection

Ojmar numérotée
3,90 € HT

ABS
35 x 20 x 10 mm
Coloris ●



Q050 - Plaque

Aluminium
1,70 € HT



Q039 - Rivet de fixation

Mâle/Femelle
0,40 € HT



Q039-1 - Rivet Ojmar

Mâle/Femelle
0,80 € HT

SÈCHE – CHEVEUX

Tarifs nous consulter

Pièces détachées modèles Vendaal et Beluga nous consulter

NOUVEAU



Rouge rubis



Bleu azur



Gris souris
nacré



Aluminium
blanc



Gris anthracite



Blanc pur

Sèche cheveux Beluga

6 coloris

2 modèles :

Fixe et sur rail

Coloris du rail :

● Aluminium blanc

○ Blanc pur

Miroir en option



Moteur



Carte
électronique



Résistance



Verrin

TABLES À LANGER ET CHAISES HAUTES



R019 - Chaise haute

6 mois à 3 ans

59 x 50 x 75,5 cm

3,9 kg

● ● ou ● ●

300,00 € HT



R019 - Table à langer

Matelas non inclus

Roues en option

PVC

100 x 65 x 95 cm

○ ●

300,00 € HT



R016 - Table à langer murale

Modèle horizontal

87,2 x 10,2 x 51 cm

9 kg

460,00 € HT



R015 - Table à langer murale

Modèle vertical

86 x 55 x 69 cm

12 kg

660,00 € HT



R020TEM - Matelas à langer

82 x 57 cm

45,00 € HT





Sécurité et surveillance

Matériels de surveillance

Matériels de sauvetage

Matériels de premiers secours

Matériels d'urgence

Accessibilité PMR



CHAISES DE SURVEILLANCE

Polypropylène
Coloris unique ●

1
↓



2
↓



3 →



1
O002-8 - Parasol
175,00 € HT

2
O002-6 - Plateau suspendu
130,00 € HT

3
O002-7 - Coussin d'assise et de dossier
115,00 € HT



O002-5 - Kit roues fixes
140,00 € HT

CHAISES DE SURVEILLANCE

Polypropylène
Coloris unique ●



O002-1 - Chaise de surveillance

1 marche
Hauteur 135 cm
Empâtement 87,5 cm
Assise 80 cm
1460,00 € HT



O002-2 - Chaise de surveillance

2 marches
Hauteur 170 cm
Empâtement 104 cm
Assise 116 cm
1755,00 € HT



O002-3 - Chaise de surveillance

3 marches
Hauteur 206,5 cm
Empâtement 120 cm
Assise 156 cm
1955,00 € HT



O002-4 - Chaise de surveillance

4 marches
Hauteur 243 cm
Empâtement 136 cm
Assise 188 cm
2515,00 € HT

SÉCURITÉ
ET SURVEILLANCE

Matériels de surveillance ■ Matériels de sauvetage ■ Matériels de premiers secours ■ Matériels d'urgence ■ Accessibilité PMR



CHAISES DE SURVEILLANCE

Marches antidérapantes
Pièces détachées sur demande



FABRIQUÉ
EN FRANCE



CLEAN002 - Chaise de surveillance

3 marches
2 roues
Inox 316L poli
100 cm
2500,00 € HT



O053M - Chaise de surveillance

3 marches
2 roues
Inox 316 électropoli
100 cm
930,00 € HT



O053 - Chaise de surveillance

5 marches
1 crochet
2 roues
Inox 316 électropoli
165 cm
1075,00 € HT



O001 - Chaise de surveillance

5 marches + 1 plateforme
2 roues
Inox 304
185 cm
2160,00 € HT



O004 - Chaise de surveillance

5 marches
Aluminium
200 cm
650,00 € HT



O053MA - Marche

Compatible avec O053 et O053M
Polyester
43,00 € HT



O001SP - Support de parasol

Incompatible avec O004
Inox
112,00 € HT



O001B - Support de bouée

5 marches
Aluminium
200 cm
57,00 € HT

MIROIRS DE SURVEILLANCE

Système de fixation inclus
 Traitement anti-âge et anti-vandalisme
 Autres dimensions et personnalisation sur demande



NOUVEAU



R065R - Miroir rond
 Ø 60 cm
 575,00 € HT



R065600 - Miroir rectangulaire
 60 x 80 cm
 550,00 € HT



R065GT - Miroir sans cadre
 100 x 80 cm
 650,00 € HT



Exemple de personnalisation

ÉQUIPEMENTS DE COMMUNICATION



O021 - Porte voix avec micro
 Micro intégré
 Puissance 30 W
 Batterie rechargeable
 1 kg
 154,00 € HT



O020W - Sifflet Wizzball
 13,80 € HT



O020B - Sifflet sans bille
 Cordon inclus
 2,80 € HT

**SÉCURITÉ
 ET SURVEILLANCE**

Matériels de surveillance ■ Matériels de sauvetage ■ Matériels de premiers secours ■ Matériels d'urgence ■ Accessibilité PMR



IP57



O050G15 - Talkie-walkie Midland G15 Pro

32 canaux PMR446 (dont 16 préprogrammés)
50 tons CTCSS + 105 codes DCS

Side tone, Scan, Moniteur, VOX

Économie de batterie automatique

Étanchéité IP67

Inclus :

- 1 émetteur-récepteur
- 1 clip ceinture
- 1 micro-écouteur
- 1 socle de charge
- 1 transformateur
- 1 batterie Li-ion 7,4 V
- 1 dragonne

155,00 € HT

Accessoires Midland G154 Pro



O050G15-1 - Base de recharge

170,00 € HT



O050G15-2 - Batterie

45,00 € HT



O050G15-3 - Socle de charge

40,00 € HT

NOUVEAU

IPX2



O050XT50 - Talkies-walkies XT50 Pro

85 canaux 569 LPD + 16 PMR446°

38 tons CTCSS en TX et RX + 83 tons DCS

Side tone, Scan, Moniteur, VOX

Jusqu'à 12 heures d'autonomie

Distance jusqu'à 8 km

Étanchéité IPX2

102 x 49 x 30 mm

Inclus :

- 2 émetteurs-récepteurs
- 2 clips ceinture
- 2 Packs de batterie 700 mAh
- 2 écouteurs MA21-Li
- 2 colliers de cou
- 1 câble de recharge USB

155,00 € HT

NOUVEAU

IPX4



O050XT70 - Talkies-walkies XT70 Pro

32 canaux PMR446 (16+16 préprogrammés) + 69 LPD

38 tons CTCSS en TX et RX + 104 tons DCS

Side tone, Scan, VibraCALL, Moniteur, VOX

Jusqu'à 12 heures d'autonomie

Distance jusqu'à 12 km

Étanchéité IPX4

120 x 53 x 35 mm

Inclus :

- 2 émetteurs-récepteurs
- 2 batteries 700 mAh Ni-MH
- 2 clips ceinture
- 2 écouteurs MA21-Li
- 2 colliers de cou
- 1 chargeur de table
- 1 adaptateur mural

170,00 € HT

PERCHES ET BOUÉES DE SAUVETAGE



O019 - Perche
Aluminium
Ø 30 mm
Au mètre linéaire
2 embouts inclus
● ○ ● ● ●
16,00€



O0480 - Système de fixation pour perche
PVC
9,00 € HT



M058 - Embout couvrant
Ø 30
3,30 € HT



O028F - Bouée de sauvetage avec sangle
105 x 15 x 8 cm
107,00 € HT

GILETS DE SAUVETAGE



Gilet de sauvetage
63938 30/40 kg ● sangle ● **58,00 € HT**
63939 40/60 kg ● sangle ● **61,00 € HT**
63940 60/80 kg ● sangle ● **65,00 € HT**
63941 > à 80 kg ● sangle ● **65,00 € HT**



Gilet de sauvetage pour enfant
836334S 2/3 ans 15/18 kg **35,00 € HT**
836334M 3/6 ans 18/30 kg **38,00 € HT**

MANNEQUINS



O012 - Ferron
Adulte 8 kg
599,00 € HT

O013 - Ferron
Scolaire 4 kg
539,00 € HT



O014 - Entraînement
Adulte 8 kg
230,00 € HT

O015 - Entraînement
Scolaire 4 kg
225,00 € HT



APPAREILS DE DIAGNOSTICS



O056 - Oxymètre de pouls
55,00 € HT



O058P - Tensiomètre de poignet
65,00 € HT



O054I - Thermomètre infrarouge
55,00 € HT



O054 - Thermomètre auriculaire
55,00 € HT

IMMOBILISATION ET TRANSFERT



O032 - Brancard pliable
Aluminium
208 x 54,5 x 13,5 cm
4,7 kg
Charge admissible 159 kg
158,00 € HT



O041 - Plan dur
Polyéthylène
184 x 45 x 7 cm
7,5 kg
Charge admissible 159 kg
170,00 € HT



O043 - Sangle de maintien
Adulte
25,50 € HT

O043E - Sangle de maintien
Enfant
22,50 € HT



O044 - Immobilisateur de tête
Compatible radiographie, IRM et CT-Scan
Vinyle
43 x 26 x 12 cm
100,00 € HT



P029J - Kit de 5 attelles
Sac de transport inclus
1 jambe 580 x 100 mm
1 bras 500 x 40 mm
1 avant-bras 400 x 40 mm
1 poignet 250 x 50 mm
1 coude/cheville 230 x 50 mm
220,00 € HT



P014 - Kit de 6 colliers cervicaux
Sac de transport inclus
6 tailles différentes
135,00 € HT



P012 - Collier cervical
Adulte
Réglable sur 4 positions
19,50 € HT

P013 - Collier cervical
Enfant
Réglable sur 4 positions
26,00 € HT

MOBILIER D'INFIRMERIE

Stratifié compact et plexiglas
Pieds en option p 73



R102 - Armoire à pharmacie
Murale
40 x 15 x 45 cm
180,00 € HT



R100 - Armoire à pharmacie
1 porte
180 x 40 x 50 cm
600,00 € HT



R101 - Armoire à pharmacie
2 portes
180 x 78 x 50 cm
900,00 € HT



O034 - Lit d'infirmier
Acier laqué époxy et simili cuir
190 x 60 x 81 cm
Charge admissible 150 kg
538,00 € HT



O039T - Tabouret à roulette
52 à 71 x Ø 50 cm
Assise Ø 38,5 x 4 cm
Charge admissible 130 kg
140,00 € HT



O033E - Marchepied 1 marche
Acier laqué époxy
40 x 24,5 x 22 cm
Charge admissible 150 kg
79,00 € HT



O033 - Marchepied 2 marches
Acier laqué époxy
40 x 24,5 x 34 cm
Charge admissible 150 kg
125,00 € HT

SÉCURITÉ
ET SURVEILLANCE



ASPIRATION



P022 - Aspirateur de mucosité manuel

Flacon 300 ml
1 sonde adulte 17 mm
1 sonde enfant 9 mm
Sac inclus
87,00€ HT

P022FL - Flacon de recharge
16,00 € HT

P022S - Sondes adulte et enfant de recharge
8,00 € HT

OXYGÉNATION



P009- Insufflateur à usage unique

T5 - Adulte
T3 - Enfant
T1 - Nourrisson
À l'unité
20,00 € HT



P009F - Filtre antiviral et antibactérien

À l'unité
3,00 € HT



P021 - Masque de poche

300 ml
À l'unité
14,00 € HT



P021U - Masque insufflateur à usage unique

Taille 0 - Nouveau-né	Ø 15 mm extérieur
Taille 1 - Bébé	Ø 15 mm extérieur
Taille 2 - Enfant	Ø 22 mm extérieur
Taille 3 - Adolescent	Ø 22 mm intérieur
Taille 4 - Adulte	Ø 22 mm intérieur
Taille 5 - Adulte fort	Ø 22 mm intérieur

Sans phtalates
À l'unité
3,50 € HT



P023C - Kit de 8 canules de Guedel

1 modèle par taille de T000 à T5
8 tailles différentes de 40 à 110 mm
Dissociables par identification-couleur
20,00 € HT

SACS DE SECOURS



P036 - Sac de secours Stratus

Compatible bouteille 5 L
Fond antidérapant
Sangles réglables par velcro
Mousse de protection dorsale
34 x 70 x 21 cm - 50 L
2,5 kg



715,50 € HT



P034A - Sac de secours Nimbus II

Compatible bouteille 5 L
Fond antidérapant
Sangles réglables par velcro
Mousse de protection dorsale
26 x 70 x 21 cm - 34 L
2,3 kg



327,50 € HT



FABRIQUÉ
EN FRANCE



OXY1034 - Sac d'oxygénothérapie Coyote

Fond doublé en Hypalon (résiste au feu et aux acides)
Anneau de treuillage et d'hélicotreuillage
Sangle porte détecteur de gaz et sangle porte-matériel
50 x 75 x 28 cm - 95 L
4,2 kg



845,00 € HT



OXY1035 - Sac d'oxygénothérapie Coyote

Fond doublé en Hypalon (résiste au feu et aux acides)
Anneau de treuillage et d'hélicotreuillage
PVC
50 x 75 x 28 cm
4,2 kg



900,00 € HT



OXY1042 - Sac d'oxygénothérapie Decal Scalp

Compatible bouteille de 2 ou 5 L
Tissu Polyamide 1680 D, imperméable, antistatique et bactériostatique
Fond doublé en Hypalon (résiste au feu et aux acides)
75 x 46 x 35 cm - 57 L
3,7 kg



845,00 € HT



P036A - Trolley pour sac de secours

Compatible avec Stratus et Nimbus II
Équipé d'une sangle de maintien
Aluminium
64 à 105 x 40 x 17 cm
1,5 kg
Charge admissible 40 kg
40,00 € HT



OPT1102 - Trolley pour sac de secours

Compatible avec Coyote et Decal Scalp
Aluminium et plastique
60 à 110 x 32 x 323 cm
1,5 kg
40,00 € HT



P037MS - Fauteuil de mise à l'eau manuelle avec contre-poids

Charge admissible 136 kg
Inox peint et polypropylène
75 x 160 x 165 cm
365 kg
7900,00 € HT



P037 - Fauteuil de mise à l'eau sur batterie BluOne

Temps de descente 23 s
Temps de montée 17 s
Charge admissible 110 kg
Acier zingué et peinture époxy
120 x 540 x 125 cm
120 kg
9200,00 € HT



P038-1 - Fauteuil de mise à l'eau sur batterie Ecpool

Temps de descente 20 s
Temps de montée 25 s
Charge admissible 136 kg
Inox et peinture époxy
182 x 59 x 156 cm
135 kg
7500,00 € HT



CLEAN007 - Fauteuil de mise à l'eau hydraulique

Charge admissible 120 kg
Inox 316L
182 x 59 x 156 cm
55 kg
6200,00 € HT



DAKOTAPISC - Fauteuil de douche Dakota

Charge admissible 110 kg
Inox 304L, roues nylon et toile Batyline®
100 x 65 x 100 cm - roues Ø 12,5 mm
15 kg
2300,00 € HT



820210/212 - Fauteuil roulant Bathmobile

Seau d'aisance inclus
Charge admissible 130 kg
Inox 304L, roues nylon et assise caoutchouc
110 x 66 x 100 cm
4,5 kg
850,00 € HT



P041AX - Siège de douche Easyroller

Charge admissible 150 kg
Plastique
82,5 x 67 x 105 cm
17 kg
1985,00 € HT



P041BS - Fauteuil roulant

Charge admissible 150 kg
Accoudoir amovible
Inox et roues polypropylène
98,5 x 70,5 x 106 cm
Assise largeur 50 cm
18 kg

2250,00 € HT



TABOURETS ET SIÈGES DE DOUCHE



P042A - Siège de douche relevable standard

364 x 382 x 500 mm - Ø 25 mm



186,00 € HT



P042A-1 - Siège de douche relevable standard

364 x 382 x 500 mm - Ø 25 mm



285,00 € HT



P042A1 - Siège de douche relevable large

585 x 360 x 500 mm



302,00 € HT



047650 - Tabouret de douche standard

335 x 385 x 485 mm - Ø 30 mm
150,00 € HT

047678 - Tabouret de douche large

490 x 330 x 650 mm - Ø 30 mm
Assise 470 mm
246,00 € HT

P042AS - Siège de douche à suspendre

317 x 503 x 367 mm
258,00 € HT

Coloris

TABOURETS ET SIÈGES DE DOUCHE

Coloris

NOUVEAU



P042N-1 - Siège de douche relevable

412 x 512 x 219 mm
302,00 € HT



P042N-2 - Siège de douche relevable avec dossier

412 x 512 x 505 mm
302,00 € HT



P042N-3 - Siège de douche relevable avec dossier et accoudoir

584 x 512 x 505 mm
302,00 € HT

**SÉCURITÉ
ET SURVEILLANCE**

BARRES D'APPUI



Charge admissible 150 kg
Avec embases
Tube elliptique 38 x 25 mm
Nylon
Coloris

NOUVEAU



P047-1 - Barre droite

30 cm 84,00 € HT
40 cm 95,00 € HT
50 cm 103,00 € HT
60 cm 109,00 € HT
80 cm 117,00 € HT
100 cm 131,00 € HT



P043 - Barre relevable

60 cm - Ø 30 mm
230,00 € HT

NOUVEAU



P051 - Barre d'appui 90°
172,00 € HT

NOUVEAU



P050 - Barre coudée 135°
170,00 € HT

Accessibilité PMR

Matériels de surveillance ■ Matériels de sauvetage ■ Matériels de premiers secours ■ Matériels d'urgence

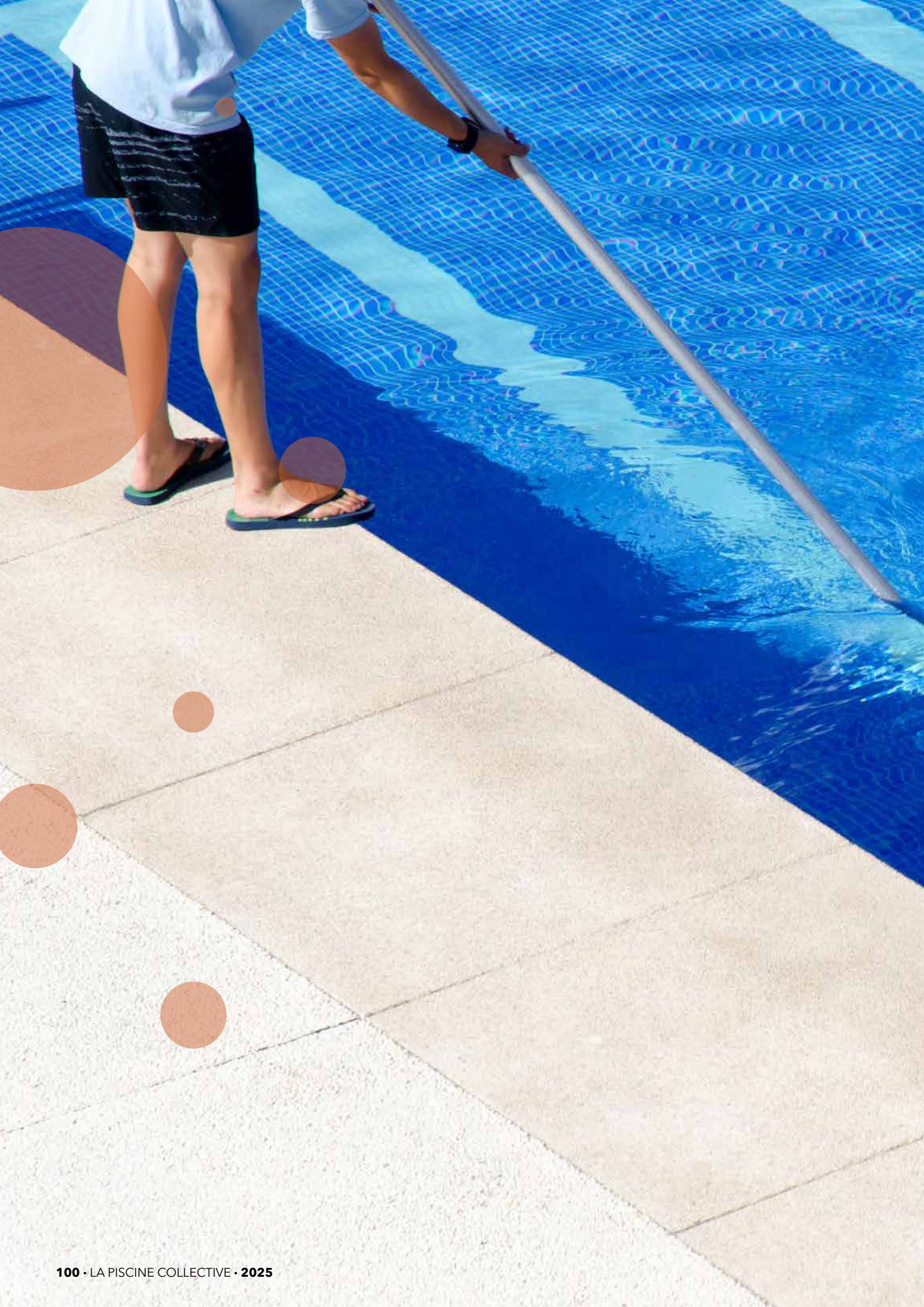



Entretien et régulation

Produits chimiques
Matériels d'entretien
Appareils de mesure
Appareils de dosage
Matériels de filtration
Matériels de rétention



A010B - Adilon B

Liquide alcalin concentré non moussant
Nettoie et dégraisse les salissures
Adapté au nettoyage haute pression
10 L
50,00 € HT



A017B - Adilon S

Liquide acide concentré peu moussant
Nettoie et détartre les salissures et les
dépôts calcaires
Adapté au nettoyage haute pression
10 L
45,00 € HT



A012B - Décalcit Super

Liquide acide concentré surpuissant
Élimine les dépôts tenaces de
calcaire sur les parois et le fond des
bassins
10 L
49,00 € HT



A013B - Demykosan Bact+

Liquide nettoyant désinfectant
Sans rinçage
Pour les sols et surfaces
10 L
85,00 € HT



A020B - Bordnet gel S

Gel acide concentré
Élimine les dépôts tenaces sur
les lignes de nage
Idéal en cas d'eau calcaire
Convient à tous les revêtements
de piscine
10 L
60,00 € HT



S013 - Nettoyant Sauna

10 L
65,00 € HT



S030 - Nettoyant Hammam

10 L
55,00 € HT

PRODUITS DE TRAITEMENT DE L'EAU

FDS sur demande
Produits français nous consulter

Filtration



B008 - Détartrant filtre liquide
5 L
15,50 € HT



B006 - Floculant liquide
20 L (24 kg)
50,00 € HT



B025 - pH moins 55%
20 L (29 kg)
40,00 € HT



B002 - pH plus
20 L (27 kg)
44,00 € HT

Désinfection



B013G - Neutralisant granulé Chlorkill
5 kg
40,00 € HT



B016 - Hypochlorite de calcium GR70 granulé non stabilisé
25 kg
160,00 € HT



B015 - Chlore granulé GR56 stabilisé
25 kg
158,00 € HT



B013 - Neutralisant chlore liquide
20 L (25 kg)
43,00 € HT

Désinfection



B019 - Chlore galet 90/250 stabilisé
25 kg
170,00 € HT



B014 - Stabilisant granulé
25 kg
155,00 € HT



B012 - Hypochlorite de sodium
Avec séquestrant pour limiter la cristallisation
20 L (25 kg)
42,50 € HT



MANCHES ET ACCESSOIRES

Fixation à clip
Fixation à vis papillon en option



F013 - Tuyau flottant
Ø 38
8, 10, 12, 15, 20, 25, 50 m
3,00 € HT



F022 - Télescopique standard à clip
Aluminium
2,4 à 4,8 m
38,00 € HT



F001 - Épuisette de fond
11,00 € HT



F003 - Épuisette de surface
10,00 € HT



F007 - Éponge pour ligne d'eau
3,10 € HT



F008 - Brosse manuelle
8,00 € HT



F011 - Brosse droite
165 mm
9,00 € HT



F012 - Brosse d'angle
3,60 € HT



F009 - Brosse de paroi
13,00 € HT



F005 - Brosse courbée
7,00 € HT



F083 - Tête de balai Fairlocks
Plastique, articulé, brosse centrale réglable et remplaçable déflecteur d'aspiration lesté
48 cm
Ø 38 int.
Ø 50 ext.
245,00 € HT



F024 - Tête de balai inox
45 cm
Ø 38 int.
Ø 50 ext.
445,00 € HT

CENTRALE DE NETTOYAGE



C155 - Centrale de Nettoyage

Nettoie et désinfecte par pulvérisation les sols et les surfaces
Se raccorde directement à un robinet
Fonctionne sans alimentation électrique ni air comprimé
Mélange le produit chimique avec l'eau par système Venturi
Température de travail maximale 50°C
Bidon 5 L
Tuyau 25 m
Raccord int. Ø 38 mm
Raccord ext. Ø 50 mm
500,00 € HT

PROTECTION DE LA PERSONNE



B017 - Masque de protection

Cartouche non incluse
105,00 € HT

B018 - Cartouche T12 ABE2

20,00 € HT



B017T - Tablier de protection

54,00 € HT



EUK - Bottes de sécurité

PVC
39 à 47
55,00 € HT



B026R - Gants en nitrile

Tailles 8/9/10
33 cm,
2,40 € HT



B026A - Gants en PVC

PVC trempé et vulcanisé
sur support jersey
40 cm
15,00 € HT



F034 - Surchaussures jetables

Taille unique
50 paires
7,50 € HT



F033LU - Surchaussures jetables deluxe

Taille unique
200 paires
205,00 € HT



F033 - Surchaussures PVC

Taille unique
La paire
15,00 € HT



THERMOMÈTRES, HYGROMÈTRES ET PH-MÈTRES



**D054 - Thermomètre
rond flottant**
0 à 40°C
15,00 € HT



**D054M - Thermomètre
géant flottant**
0 à 45°C
65,00 € HT



**D056 - Thermomètre
flottant**
0 à 45°C
20,50 € HT



D047 - Thermomètre/pH-mètre
Sonde intégrée
température de 0 à 50°C
pH de 0 à 14
IP67
150,00 € HT



MOIN003 - Thermomètre infrarouge
-50 à 760°C
140,00 € HT



**D070A-1 - Thermomètre
digital type K**
Sonde incluse
99,00 € HT

D070-S - Sonde filaire type K
100 cm
180,00 € HT



D072 - Thermomètre/hygromètre
Température -10° à 40°C
Hygrométrie 0 à 100 %
178,00 € HT



D070A - Thermomètre sonde
-50 à 300°C IP65
118,00 € HT



05631080 - Thermomètre 108
-50 à 300°C
IP6
212,00 € HT



D028 - Photomètre MD200 3 en 1
Mesure le chlore, le pH et l'acide cyanurique
635,00 € HT



D033 - Photomètre MD200 « 5 en 1 »
Mesure le chlore, le pH, l'acide cyanurique,
l'alcalinité totale et la dureté calcique
775,00 € HT



807850 - Photomètre Pooltest 6
Mesure le chlore, le pH, l'acide cyanurique, la dureté calcique, l'alcalinité et le brome
690,00 € HT



VAT0002 - Mallette d'analyse Triklorame V2
1 poste d'analyse trichloramine dans l'air
2955,00 € HT

VAT0020 - Kit de 20 mesures de Trichloramine
588,00 € HT

NOUVEAU



D053 - Photomètre portable Lilian
Mesure le pH et le chlore libre/total
Analyses réalisées en 1 minute
Inclus :
• 1 photomètre
• 3 gobelets doseurs
• 1 support d'analyses
• 1 chargeur de batteries
• 1 pince brucelles
• 1 kit de maintenance
• 1 guide de démarrage
1899,00 € HT

D053-1 - SensoStick
Pour photomètre Lilian
Lot de 300 capteurs
750,00 € HT





D030 - Kit standard de référence pH
Pour photomètre MD200
100,50 € HT



D029 - Kit standard de référence chlore
Pour photomètre MD200
100,50 € HT



D014 - Agitateur
13 cm
3,80 € HT



D032P - Éprouvettes
48 mm
Lot de 5
178,50 € HT



D0325 - Éprouvettes
48 mm
Lot de 5
45,00 € HT



D016 - DPD n°1
Boite de 250
17,50 € HT



D017-2 - DPD n°2
Boite de 250
73,00 € HT



D017 - DPD n°3
Boite de 250
17,00 € HT



D0174 DPD n°4
Boite de 250
50,00 € HT



D045 - Rouge de Phénol
Boite de 250
15,00 € HT



D019 - Acide cyanurique
Boite de 250
20,00 € HT



D064 - Glycine
Boite de 100
38,00 € HT

CARNETS SANITAIRES

Couverture rigide
4 bassins + 1 pédiluve par page
370 pages



D022 - Carnet sanitaire
Reliure collée
33,00 € HT



D022S - Carnet sanitaire
Reliure à spirale
34,50 € HT

ENSEMBLES DE RÉGULATION

Fiches techniques sur demande
Autres modèles de régulation nous consulter



Tero
Nous consulter



Odi Touch
Nous consulter



Gamme Bayrol
Nous consulter

Accessoires



E007 - Membrane pour sonde chlore
150,00 € HT



E004 - Sonde chlore
1900,00 € HT



E005 - Sonde pH
168,00 € HT



E008 - Gel pour membrane
75,00 € HT



POMPES DOSEUSES

Fiches techniques sur demande



Pompe doseuse Eco-Plus

C014	16 bars	1,1 L/h	4 x 6
C015	7 bars	3,9 L/h	4 x 6
C016A	3 bars	9,0 L/h	5 x 8
C017	1,5 bars	16,4 L/h	5 x 8
SY018	1,5 bars	21,9 L/h	5 x 8



Beta

Pompes de dosage péristaltiques

Nous consulter



Canne d'injection

C018	Tubing 4 x 6	115,00 € HT
C019	Tubing 5 x 8	115,00 € HT
C032	Tubing 8 x 12	75,00 € HT



Crépine d'aspiration

C023	Tubing 4 x 6	100,00 € HT
C024	Tubing 5 x 8	120,00 € HT
C036	Tubing 8 x 12	120,00 € HT



Bobine de 100 m en PE

C020	4 x 6	51,00 € HT
C021	5 x 8	78,00 € HT
C059	8 x 12	215,00 € HT



Bobine de 50 m en PVDF

APP001	4 x 6	160,00 € HT
APP002	5 x 8	325,00 € HT
APP003	9 x 12	590,00 € HT

DOSEURS À GALETS – MATÉRIELS DE FILTRATION



C043B - Doseur à galets
Capacité 3,5 kg
130,00 € HT



C042 - Doseur à galets
Capacité 0,25 kg
27,00 € HT



C001 - Diatomées FW60
20 kg
80,00 € HT

PLATEAUX ET PLATEFORMES DE RETENTION



ST1-40-B-BK - Plateau 60 L

155 x 800 x 600 mm

75,00 € HT

ST1-60-B-BK - Plateau 87 L

175 x 1000 x 600 mm

80,00 € HT

ST1-100-B-BK - Plateau 143 L

175 x 1200 x 800 mm

96,00 € HT

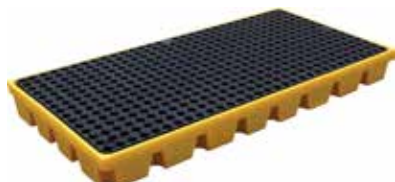

SJ-300-001 - Plateforme 112 L

1600 x 150 x 800 mm

359,00 € HT



C051PR60 - Plateforme 60 L

1000 x 600 x 175 mm

180,00 € HT

C051PAL40 - Plateforme 40 L

800 x 600 x 155 mm

130,00 € HT

C051PEHD - Plateforme 100 L

1200 x 800 x 175 mm

200,00 € HT

POMPES DE TRANSVASEMENT

Pompe vide-fûts Lutz B2 Vario

Conçu pour le retrait de fluides de faible épaisseur, aqueux ou légèrement visqueux

- Régulateur de vitesse en continu avec interrupteur marche/arrêt
- Débit maximal 75 L/min
- Température d'utilisation maximale 50°C



C067-7

Polypropylène
Canne 700 mm
990,00 € HT



C067I-7

Inox
Canne 700 mm
1499,00 € HT

C067-1

Canne 1000 mm
1140,00 € HT

C067I

Canne 1000 mm
2200,00 € HT

2025 : l'année du renouveau

Depuis 2009, **LPC** met son expertise en matière d'équipements professionnels pour les piscines au service des **collectivités**, des **associations** et des **professionnels**. Au fil des années, nous avons su étoffer notre catalogue, en mettant un point d'honneur à sélectionner des équipements alliant qualité, ergonomie et durabilité. Aujourd'hui, nous proposons un large choix de produits qui saura répondre à l'ensemble de vos besoins, **du standard au sur-mesure**.

Sensible aux enjeux sociétaux, nous nous appliquons à vous proposer davantage de produits **fabriqués en France** et issus de circuits courts. Bien qu'il soit aujourd'hui impossible de vous présenter un catalogue 100 % français, nous nous attachons à vous proposer des produits majoritairement **fabriqués en Europe**. Nous élargissons également notre gamme de produits fabriqués à partir de **matières recyclées et recyclables**.

Pour 2025, vous découvrirez du **mobilier en PVC recyclé**, **trois toboggans LPC**, dont un Monogliss, des brassards en mousse LPC ergonomiques et durables, ainsi que des **systèmes d'attaches LPC** pour vos activités ludiques. Nous avons réorganisé notre service logistique pour vous garantir des délais de livraison optimaux. Notre site internet nouvellement rénové propose des fonctionnalités pratiques vous permettant d'établir vos devis incluant les frais de port et les remises le cas échéant.

L'équipe LPC

Devis, projets et données techniques :

Pierre-Emmanuel BEDOUIN

Gérant

06.83.29.74.98

contact@lapiscinecollective.com

Christophe HELLEC

Commercial

06.70.71.27.95

c.hellec@lapiscinecollective.com

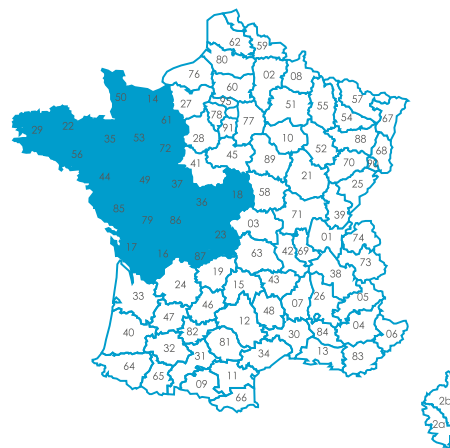
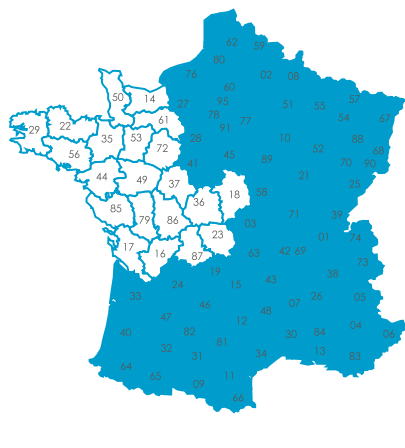

Demande d'information et SAV :

contact@lapiscinecollective.com

Suivi des commandes :

commande@lapiscinecollective.com

Facturation :

compta@lapiscinecollective.com

À Francine

Nous ne pouvons conclure ce catalogue sans avoir une pensée particulière pour notre chère collègue Francine KIEHL, commerciale de la région Sud-Est, qui nous a quittés en fin d'année dernière. Elle aurait fêté ses 11 ans d'ancienneté chez LPC cette année.

1. PRIX

Sauf conditions particulières, les prix sont établis en euros, net de toutes remises, départ entrepôt, hors transport et hors taxes. Les prix sont donnés à titre indicatif et peuvent être révisés à tout moment. Les prix applicables sont ceux en vigueur au jour de l'acceptation de la commande.

2. DEVIS

Les devis ont une durée de validité de 15 jours à compter de leur date d'édition. Les devis constituent un contrat dès lors qu'ils sont signés par les deux parties.

3. COMMANDE

Les commandes sont confirmées uniquement par écrit, sur papier ou support électronique. Le client qui transmet une commande accepte, de fait et sans réserve, les conditions de vente et renonce à toute application de ses éventuelles conditions générales d'achat.

Le minimum de commande est fixé à 100,00 € HT. Pour toute commande inférieure à ce montant, la somme de 12,00 € HT sera facturée pour couvrir les frais de traitement et de facturation.

4. DÉLAI

Les délais de livraison sont donnés à titre indicatif et sont sans garantie. LPC peut procéder à des livraisons partielles. Si le bien n'est pas livré à la date indiquée, l'acheteur ne peut annuler la vente ni refuser le bien, et cela ne peut donner droit à retenue, pénalité, dédommagement ou refus de paiement de la facture correspondante.

5. LIVRAISON

Lors de la livraison des biens :

- Ouvrir et inspecter chaque carton et palette en présence du chauffeur
- Noter chaque défaut de façon la plus précise possible (article, quantité, description de la casse) sur le bordereau de livraison
- Prendre des photos des détériorations constatées
- Sans cela, aucune démarche de notre part ne sera possible

En cas de retard, perte, avarie, vol, erreur, manquant ou défaut il appartient au client de prendre l'initiative de la réclamation auprès du transporteur, et ce, dans le délai de 3 jours.

Franco de port à partir de 3 000 € net HT.

6. TRANSPORT

Aucun retour de marchandises ne pourra s'effectuer avant accord de notre service commercial. Le retour doit être effectué soit en port payé, soit par enlèvement de notre transporteur à notre demande. Tous les envois en port dû seront systématiquement refusés.

7. PAIEMENT

Les conditions de paiement s'entendent comptant sans escompte à la réception de la facture. Règlement par mandat administratif : les conditions sont les conditions légales en vigueur à la date de la facture sans escompte.

Règlement différé : Il devra s'effectuer par traite signée, par chèque ou par virement. Des pénalités de retard au taux de l'intérêt légal de 1,5% seront systématiquement appliquées. LPC peut suspendre les commandes en cours et exiger le paiement immédiat de toutes les factures impayées.

8. RETOUR

Tout retour doit faire l'objet d'un accord formel et écrit entre le client et LPC. Aucun retour de marchandises ne pourra s'effectuer sans accord. Le retour doit être effectué soit en port payé, soit par enlèvement organisé par LPC. Tous envois en port dû seront systématiquement refusés.

9. GARANTIE

La garantie est de 2 ans à compter de la délivrance du bien, hors pièces d'usure. La garantie est renouvelée pour 2 ans à compter du remplacement du bien. La garantie est strictement limitée à la remise en état ou au remplacement du bien reconnu par LPC comme présentant un vice de fabrication, à l'exclusion de tout dédommagement à quelque titre que ce soit.

La garantie ne s'applique pas pour les cas suivants :

- Le client a connaissance des défauts au moment de la commande
- Les défauts sont liés à l'usure naturelle du bien
- Les défauts sont liés à une utilisation, un entretien ou un stockage non conforme
- Les défauts sont liés à un mauvais montage effectué par le client
- Les défauts sont liés à une modification initiée par le client

10. PROTECTION DES DONNÉES PERSONNELLES

Conformément à la loi informatique et libertés du 6 Janvier 1978, le client dispose des droits d'interrogation, d'accès, de modification, d'opposition et de rectification sur les données le concernant.

11. RÉCLAMATION

Le cas échéant, le client peut présenter toute réclamation en contactant LPC :

LPC - La Piscine Collective
43 rue des Taillandiers - 72800 Le Lude
02.43.45.19.60
contact@lapiscinecollective.com

12. TRIBUNAL COMPÉTENT

Toute contestation sera réglée expressément par le Tribunal de Commerce du Mans statuant en application du Droit français.

13. CONCILIATION

Dans l'éventualité d'un litige et avant toute saisie du tribunal Commerce du Mans, le demandeur devra, conformément au décret 2015.282 du 11 mars 2015, et plus particulièrement des articles 18 et 19, tenter une résolution à l'amiable dudit litige par voie de conciliation.



LPC – LA PISCINE COLLECTIVE

43 rue des Taillandiers
72800 – Le Lude
France

02 43 45 19 60
contact@lapiscinecollective.com
www.lapiscinecollective.fr